

C O L L E C T I O N

2019



S Û L I O N







**Lámparas Schuller S.A., hoy conocido como SÛLION, nació en 1967 como un taller donde se diseñaban y fabricaban luminarias. Los fundadores, Carlos y Regina, han sido testigos de cómo este negocio familiar ha ido creciendo hasta transformarse en una empresa consolidada en el sector de la iluminación.**

**SULION se compone de un equipo profesional de más de 40 personas donde todos los días nos esforzamos por ser una de las empresas de iluminación y ventilación de referencia.**

---

*Lámparas Schuller S.A., now known as SÛLION, was born in 1967 as a workshop designing and manufacturing luminaries. The founders, Carlos and Regina, have witnessed how this family business has grown to become a consolidated company in the lighting sector. Behind SÛLION is a team of more than 40 professionals, who strive every day to be one of the reference lighting and ventilation companies.*

---

*Lámparas Schuller S.A., maintenant connue sous le nom de SÛLION, est née en 1967 comme un atelier de conception et de fabrication de luminaires. Les fondateurs, Carlos et Regina, ont vu comment cette entreprise familiale s'est développée pour devenir une entreprise consolidée dans le secteur de l'éclairage. SÛLION est composée d'une équipe de professionnels de plus de 40 personnes, qui s'efforcent chaque jour pour devenir l'une des sociétés de référence en éclairage et ventilation.*

---

*Lámparas Schuller S.A., agora conhecida como SÛLION, nasceu em 1967 como uma oficina onde as luminárias foram projetadas e fabricadas. Os fundadores, Carlos e Regina, testemunharam como esse negócio familiar cresceu e se tornou uma empresa consolidada no setor de iluminação.*

*A SULION é composta por uma equipe profissional de mais de 40 pessoas, onde todos os dias nos esforçamos para ser uma das empresas de iluminação e ventilação de referência.*

---

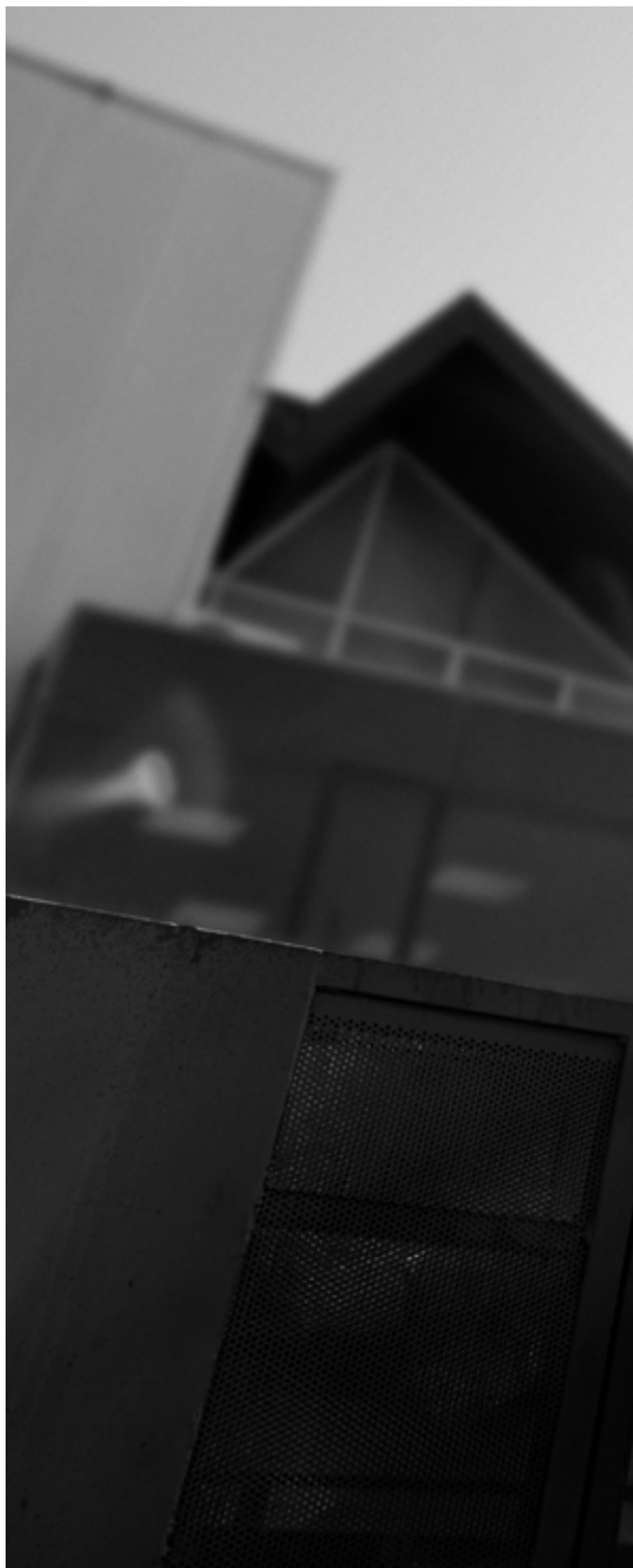









**Somos una compañía española pionera en ventiladores de techo, además de especialistas en diseño de productos de iluminación con altas prestaciones de calidad y técnicas.**

**Ofrecemos tecnología decoración en todos nuestros productos con una relación calidad/precio insuperable, y asesoramiento personalizado a nuestros clientes.**

---

*We are a Spanish company, pioneer in the field of ceiling fans , as well as specialists in designing lighting products with high quality and advanced technical features.*

*We offer technology and design in all our products with an outstanding price / quality ratio, and personalized advice to our customers.*

---

*Nous sommes une entreprise espagnole pionnière dans le domaine des ventilateurs de plafond, ainsi que spécialistes dans la conception de produits d'éclairage de haute qualité et dotés de caractéristiques techniques de dernière génération.*

*Nous proposons technologie et design dans tous nos produits avec un rapport qualité / prix imbattable et des conseils personnalisés à nos clients.*

---

*Somos uma empresa espanhola que é pioneira em ventoinhas de teto, bem como especialistas em design de produtos de iluminação com alta qualidade e características técnicas.*

*Oferecemos tecnologia de decoração em todos os nossos produtos com uma relação preço / qualidade imbatível e aconselhamento personalizado aos nossos clientes.*

---





**C O L L E C T I O N**

**2019**

INDOOR

ARENADO  
114

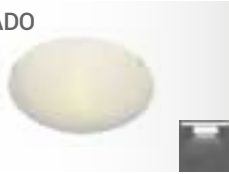

CENEFA  
124



FACTORY  
110



HILL  
140



ARM  
66



CURLY  
102



FLAT  
116



HUNT  
108



ARON  
75



CUSTOLI-  
GHT  
46



FLYNN  
40



JOKKMOKK  
134



ASSSER  
60



DEEL  
140



FRONT  
50



KAHOY  
73

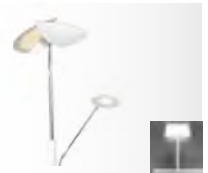

BARGELD  
122



DEVIS  
104



FULINO  
88



KARLOFF  
146



BASIC  
79



DIEM  
25

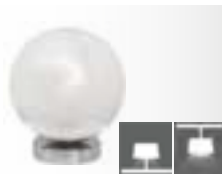

GUERTY  
66



KLEE  
96



BED  
62



DRAPER  
108



GYPSUM  
50



KODY  
92

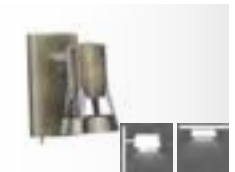

CANDY  
141



EBRO  
130

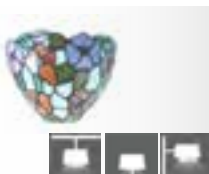

HALE  
29



LÁGRIMAS  
114



CARRY  
86



EPSILON  
70

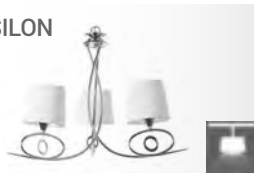

HAWKING  
60

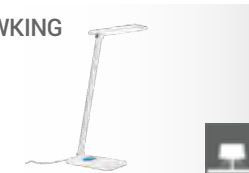

LIENZ  
64



INDOOR

LOLA  
68



NORDIC  
42

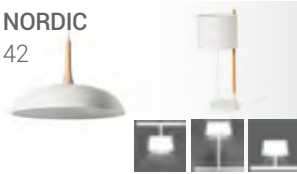

STERN  
144



VINTAGE  
58



LULEA  
137



PICABIA  
120



TAFLA  
118



VOLEA  
36



MAIER  
19



POLON  
90



TAVEDA  
32



WALL  
106



MARTÍN  
51



RADOM  
16

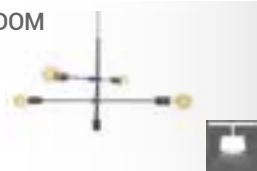

TINN  
141



YANGON  
34



MORAN  
100



READ  
62



TORTUGA  
129



NAOMI  
132

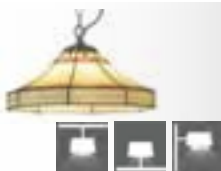

SAVOY  
34



TORÚN  
21



NATURE  
94



SCALE  
48



TOUCH  
60



NAVY  
112



SELMA  
98



VENUS  
149

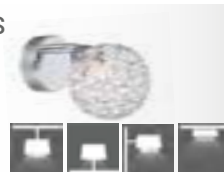

NORCIA  
77

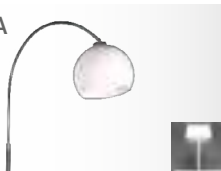

STELA  
24

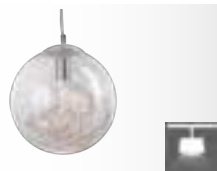

VIDRIERA  
126

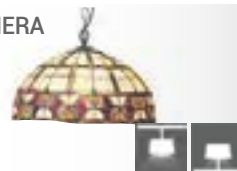



TECHNICAL

ALPHA  
188



DOTFIX  
154



PEAK  
207



T5 LINE  
214



ARC  
167



DUCK  
158



PEG  
177



TAPE  
198



ARUMFIX  
160



DW360  
204



PENN  
178

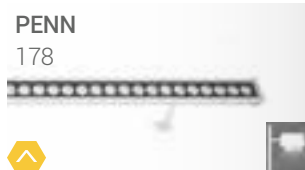

THIN  
176



ASTON  
190



FULL  
226



PLATE  
202



THOR  
172



BECOO  
184



HOLE  
216



RAYFIX  
190

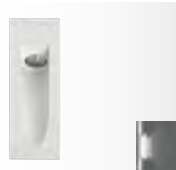

TRIME  
182



BELOW  
184

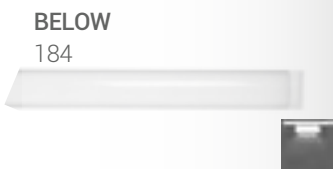

HOLEGLAS  
230



SAND  
167

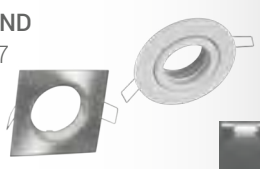

TURK  
169



BUGY  
174



KITCH  
186



SENSE  
224



TWIS  
228

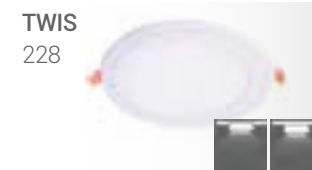

CIFO  
196

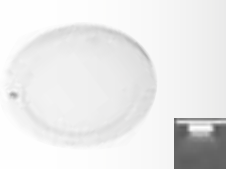

KORU  
210



STRIP LED PROFESIONAL  
232



VISIO  
162



COLOSSAL  
192



LINDEFIX  
190

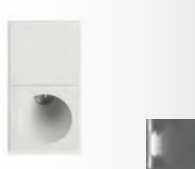

SURF  
217





BATHROOM

AQUARUM  
242



CURVES  
250



FAST  
244



PLURIEL  
248



BULA  
252



DOUCHE  
240



NATURE  
246



TUBES  
254



OUTDOOR

BEWATER  
258



COB FROST  
276



LOPE  
280



RAPHA  
292



BUILT  
297



COBSOIL R  
282



MASINI  
300



RECORD  
288



CANADIAN  
295



DEEP  
260

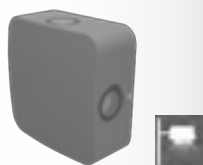

NEW ERA  
274



THIN+  
284



COBAQUA  
286



GRASS  
293



OUTDOOR  
290



TISA  
262

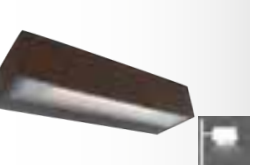

COB DEW  
272



KAMAL  
267



PEG+  
284



YUKA  
284



COB FOUNT  
270



KOPYO  
278



PENN+  
264

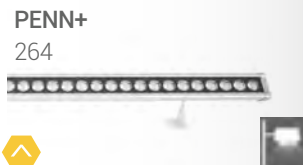

SOLAR

BIRD  
308



KIPPER  
306



NEKO  
312



SUNY  
310



FAN

ANKE  
347



CIRROS  
341



GALILEO<sub>m</sub>  
373



MAVERICK  
364



ATUAIRE  
333



CORMORAN  
346



HANDAIR  
331

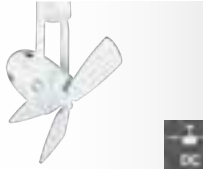

METEOR  
351



BALLOO+  
377



DALLAS  
381



HANNA  
330



MUSTANG  
372



BALLOO  
345



DIAMOND<sub>n</sub>  
361



HORNET  
348



NERHEA  
362

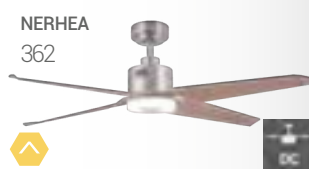

BERNAT  
358



FIERA  
357



JALON  
375



NEWTON  
342



BOMBAY  
343



FLORA  
337



LOWA  
356



OLYMPIA  
380



BROMIEN  
371



GADES  
366



MARCONY  
374



RAHU  
355



F A N

RAINBOW  
335



SKUA  
379



WESTLAND  
349



RUBIK  
329



SONET  
367



SARAH  
363



VADIS  
369



ELECTRONICS

DRIVER  
316



CONTROLADORES  
317



AMPLIFICADORES  
317





I N D O O R



# R A D O M



**RADOM** | COLGANTE | **6x60W E27** | máx. 250V ~50-60Hz

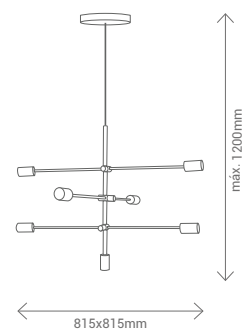

M



| REF    | W Máx.  |     | COLOR |
|--------|---------|-----|-------|
| 190110 | 6 x 60W | E27 | negro |

**RADOM** | COLGANTE | **4x60W E27** | máx. 250V ~50-60Hz

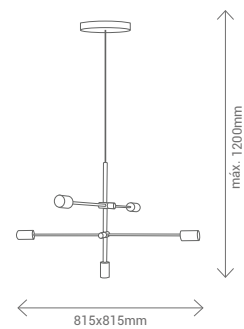

M



| REF    | W Máx.  |     | COLOR |
|--------|---------|-----|-------|
| 190112 | 4 x 60W | E27 | negro |





# MAIER



MAIER | COLGANTE | LED 36W | 220-240V ~50-60Hz

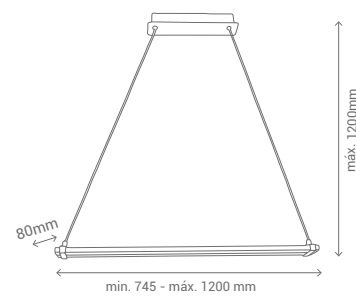

M + AC



| REF    | CCT   | LM   | COLOR  |
|--------|-------|------|--------|
| 262550 | 4000K | 2880 | níquel |



# TORÚN



**TORÚN** | APLIQUE | 1x60W E27 | máx. 250V ~50-60Hz

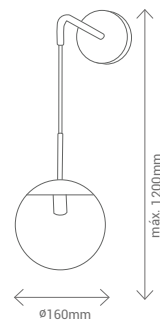

M + G

IP 20

| REF    | W Máx.  |     | COLOR  |
|--------|---------|-----|--------|
| 190100 | 1 x 60W | E27 | dorado |

**TORÚN** | COLGANTE | 1x60W E27 | máx. 250V ~50-60Hz

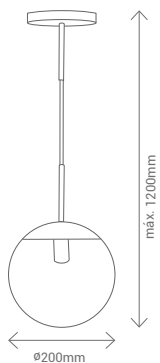

M + G

IP 20

| REF    | W Máx.  |     | COLOR  |
|--------|---------|-----|--------|
| 190130 | 1 x 60W | E27 | dorado |

**TORÚN** | COLGANTE | 1x60W E27 | máx. 250V ~50-60Hz

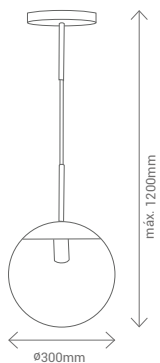

M + G

IP 20 270°

| REF    | W Máx.  |     | COLOR  |
|--------|---------|-----|--------|
| 190135 | 1 x 60W | E27 | dorado |



# STELA



**STELA** | COLGANTE | LED 8W + 1x60W E27 | 110-240V ~50-60Hz

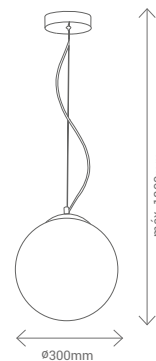

| REF    | CCT   | Lm  |     | COLOR  |
|--------|-------|-----|-----|--------|
| 187040 | 2800K | 320 | E27 | chromo |

# DIEM

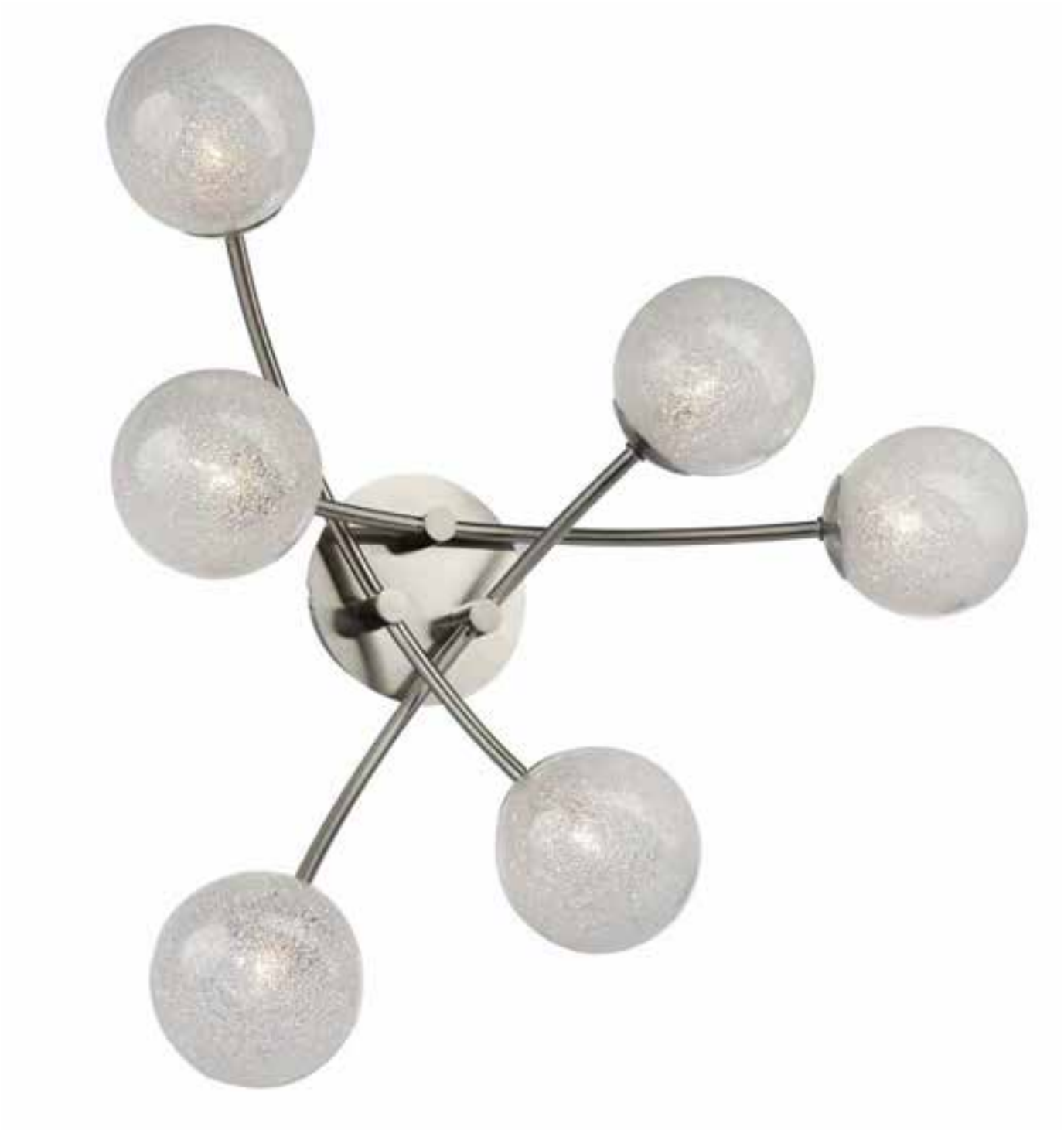



DIEM | COLGANTE | 1x60W E27 | 220-240V ~50-60Hz

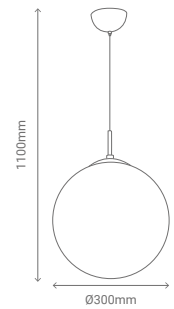

M + G



| REF    | W Máx. |     | COLOR  |
|--------|--------|-----|--------|
| 210107 | 60W    | E27 | chromo |

DIEM | SOBREMESA | 1x60W E27 | 220-240V ~50-60Hz

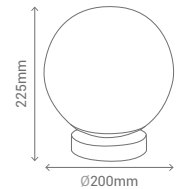

M + G



| REF:   | W Máx. |     | COLOR  |
|--------|--------|-----|--------|
| 210108 | 40     | E27 | níquel |



**EFEECTO ESCARCHA DE CRISTAL**  
Diamond sand finish | Effet verre givré | Efeito geado



DIEM | APLIQUE | 1x28W G9 | 220-240V ~50-60Hz

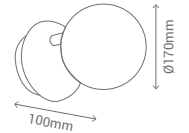

| REF    | W Máx. |    | COLOR  |
|--------|--------|----|--------|
| 210100 | 1x28W  | G9 | níquel |

DIEM | APLIQUE | 2x28W G9 | 220-240V ~50-60Hz

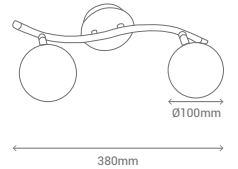

| REF    | W Máx.  |    | COLOR  |
|--------|---------|----|--------|
| 210101 | 2 x 28W | G9 | níquel |

DIEM | APLIQUE | 2x28W G9 | 220-240V ~50-60Hz

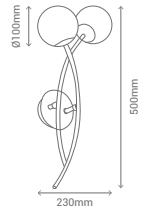

| REF    | W Máx.  |    | COLOR  |
|--------|---------|----|--------|
| 210106 | 2 x 28W | G9 | níquel |

DIEM | PLAFÓN | 3x28W G9 | 220-240V ~50-60Hz

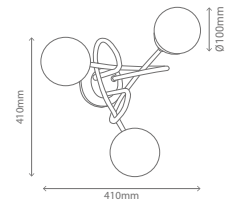

| REF    | W Máx.  |    | COLOR  |
|--------|---------|----|--------|
| 210102 | 3 x 28W | G9 | níquel |

DIEM | PLAFÓN | 4x28W G9 | 220-240V ~50-60Hz

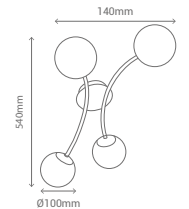
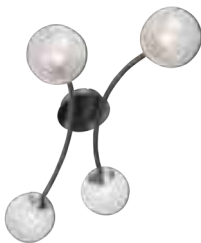

| REF    | W Máx.  |    | COLOR  |
|--------|---------|----|--------|
| 210103 | 4 x 28W | G9 | níquel |

DIEM | PLAFÓN | 6x28W G9 | 220-240V ~50-60Hz

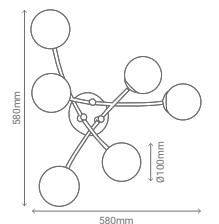
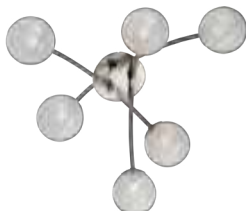

| REF    | W Máx.  |    | COLOR  |
|--------|---------|----|--------|
| 210104 | 6 x 28W | G9 | níquel |



# H A L E



HALE | COLGANTE | LED 32W | 220-240V ~50-60Hz

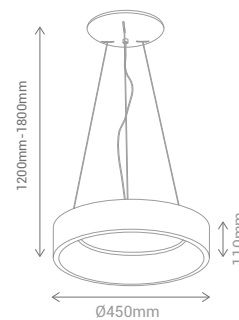
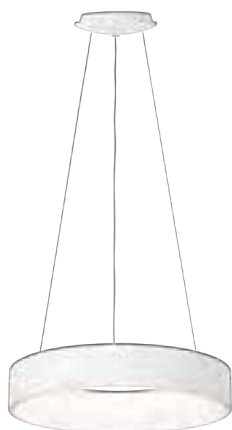

M + AC



| REF    | CCT   | LM   | COLOR  |
|--------|-------|------|--------|
| 114020 | 4000K | 2000 | blanco |
| 114022 | 2700K | 2100 | blanco |

HALE | COLGANTE | LED 42W | 220-240V ~50-60Hz

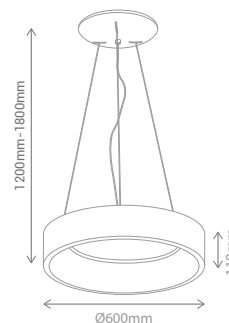
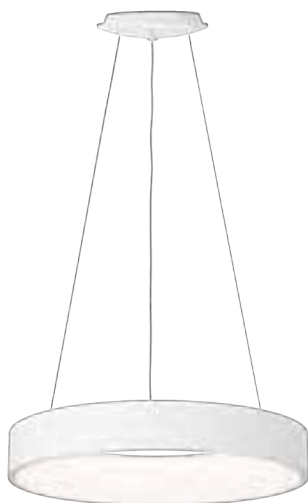

M + AC



| REF    | CCT   | LM   | COLOR  |
|--------|-------|------|--------|
| 114030 | 4000K | 2700 | blanco |
| 114032 | 2700K | 2800 | blanco |





# TAVEDA



TAVEDA | COLGANTE | LED 32W | 220-240V ~50-60Hz

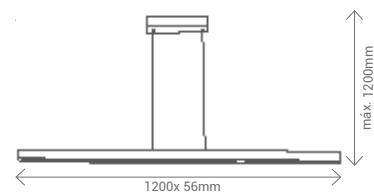

| REF    | CCT   | LM   | COLOR  |
|--------|-------|------|--------|
| 114104 | 3000K | 2600 | Madera |



SAVOY

YANGON





**YANGON** | COLGANTE | 1x60W E27 | máx. 250V ~50-60Hz

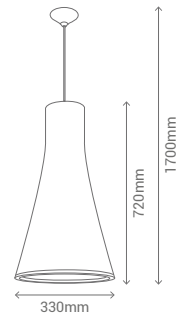

| REF    | W Máx.  |     | COLOR  |
|--------|---------|-----|--------|
| 187090 | 1 x 60W | E27 | Madera |

**SAVOY** | COLGANTE | 1x60W E27 | máx. 250V ~50-60Hz

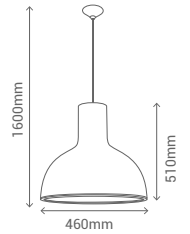

| REF    | W Máx.  |     | COLOR  |
|--------|---------|-----|--------|
| 187092 | 1 x 60W | E27 | Madera |



# V O L E A



**VOLEA | COLGANTE | LED 28W | 220-240V ~50-60Hz**

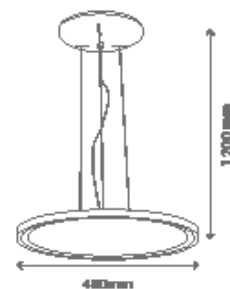

M + AC



| REF    | CCT   | LM   | COLOR  |
|--------|-------|------|--------|
| 166609 | 2700K | 2300 | blanco |
| 166618 | 4000K | 2400 | blanco |

**VOLEA | COLGANTE | LED 45W | 220-240V ~50-60Hz**

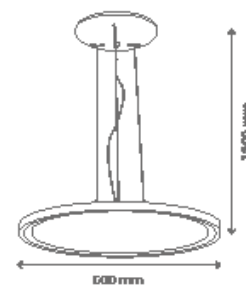
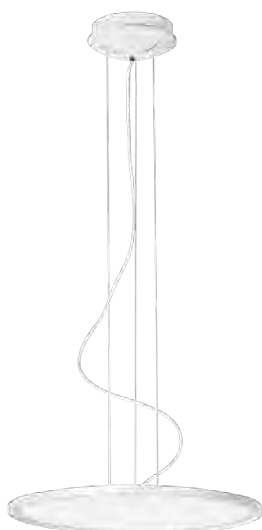

M + AC



| REF    | CCT   | LM   | COLOR  |
|--------|-------|------|--------|
| 166632 | 2700K | 3500 | blanco |
| 166631 | 4000K | 3600 | blanco |

**VOLEA | COLGANTE | LED 96W | 220-240V ~50-60Hz**

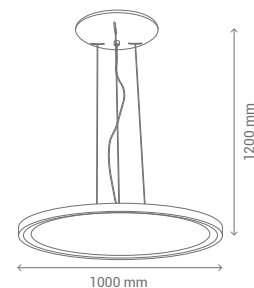
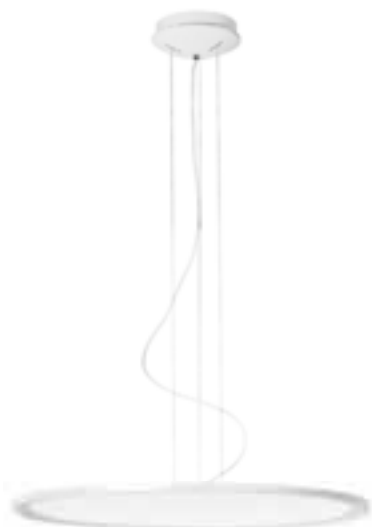

M + AC



| REF    | CCT   | LM   | COLOR  |
|--------|-------|------|--------|
| 200112 | 2700K | 8000 | blanco |
| 200111 | 4000K | 8100 | blanco |





**VOLEA | PLAFÓN | LED 45W** | 220-240V ~50-60Hz



M + AC

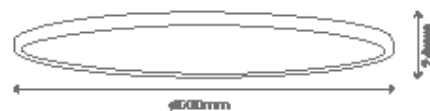

| REF    | CCT   | LM   | COLOR  |
|--------|-------|------|--------|
| 166642 | 2700K | 3500 | blanco |
| 166641 | 4000K | 3600 | blanco |

**VOLEA | PLAFÓN | LED 96W** | 220-240V ~50-60Hz



M + AC

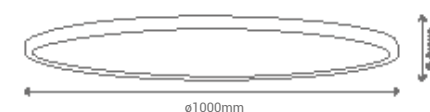

| REF    | CCT   | LM   | COLOR  |
|--------|-------|------|--------|
| 200104 | 2700K | 8000 | blanco |
| 200101 | 4000K | 8100 | blanco |

F L Y N N



**FLYNN | COLGANTE | 1x60W E27 |** máx. 250V ~50-60Hz

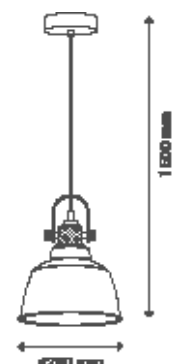

| REF    | W Máx.  | W   | COLOR          |
|--------|---------|-----|----------------|
| 189914 | 1 x 60W | E27 | negro + dorado |

**FLYNN | APLIQUE | 1x60W E27 |** máx. 250V ~50-60Hz

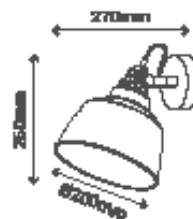

| REF    | W Máx.  | W   | COLOR          |
|--------|---------|-----|----------------|
| 189905 | 1 x 60W | E27 | negro + dorado |



# N O R D I C





**NORDIC | COLGANTE | 1x60W E27 |** máx. 250V ~50-60Hz

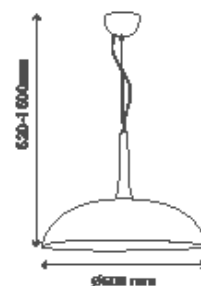

| REF    | W Máx.  |     | COLOR         |
|--------|---------|-----|---------------|
| 187091 | 1 x 60W | E27 | blanco/madera |

**NORDIC | COLGANTE | 1x60W E27 |** máx. 250V ~50-60Hz

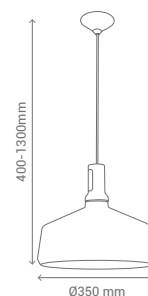

| REF    | W Máx.  |     | COLOR         |
|--------|---------|-----|---------------|
| 187094 | 1 x 60W | E27 | blanco/madera |

**NORDIC | SOBREMESA | 1x60W E27 |** máx. 250V ~50-60Hz



| REF    | W Máx.  |     | COLOR         |
|--------|---------|-----|---------------|
| 187075 | 1 x 60W | E27 | blanco/madera |

**NORDIC** | PIE DE SALÓN | 1x60W E27 | máx. 250V ~50-60Hz

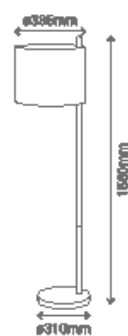

| REF    | W Máx.  |     | COLOR         |
|--------|---------|-----|---------------|
| 187076 | 1 x 60W | E27 | blanco/madera |

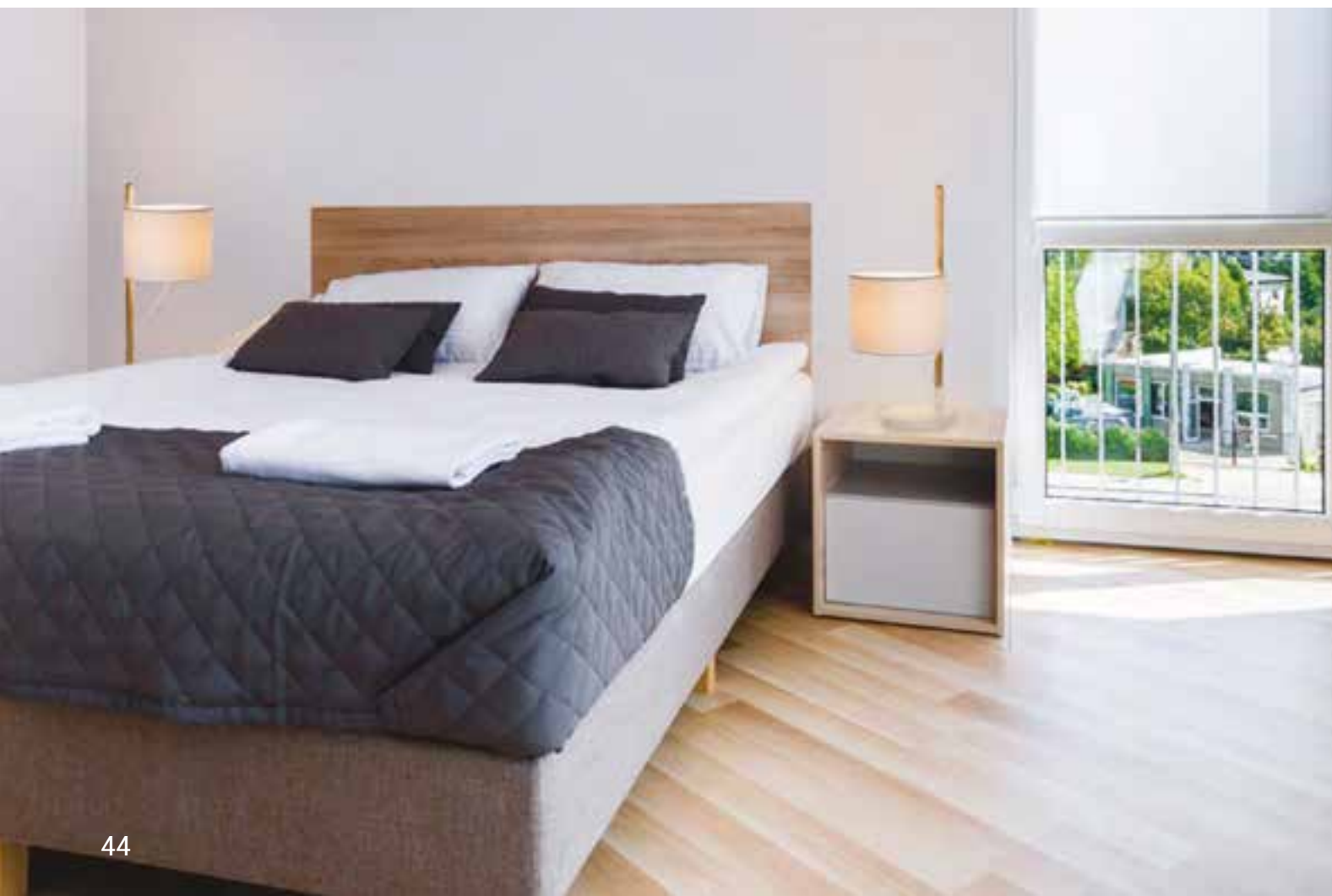



# C U S T O L I G H T





CUSTOLIGHT | COLGANTE | 5W GU10 | máx. 250V ~50-60Hz

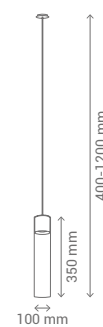

M + G



| REF    | CCT   | LM  | COLOR              |
|--------|-------|-----|--------------------|
| 982351 | 3000K | 400 | cromo/transparente |



# SCALE



SCALE | COLGANTE | SMD 36W | 220-240V ~50-60Hz

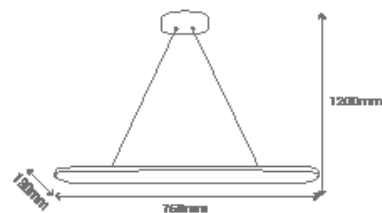

M + AC



| REF    | CCT   | LM   | COLOR  |
|--------|-------|------|--------|
| 200202 | 2700K | 3000 | blanco |
| 200200 | 4000K | 3100 | blanco |

SCALE | COLGANTE | SMD 60W | 220-240V ~50-60Hz

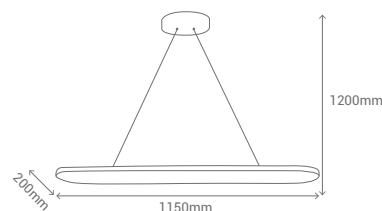

M + AC



| REF    | CCT   | LM   | COLOR  |
|--------|-------|------|--------|
| 200203 | 2700K | 5400 | blanco |
| 200201 | 4000K | 5600 | blanco |

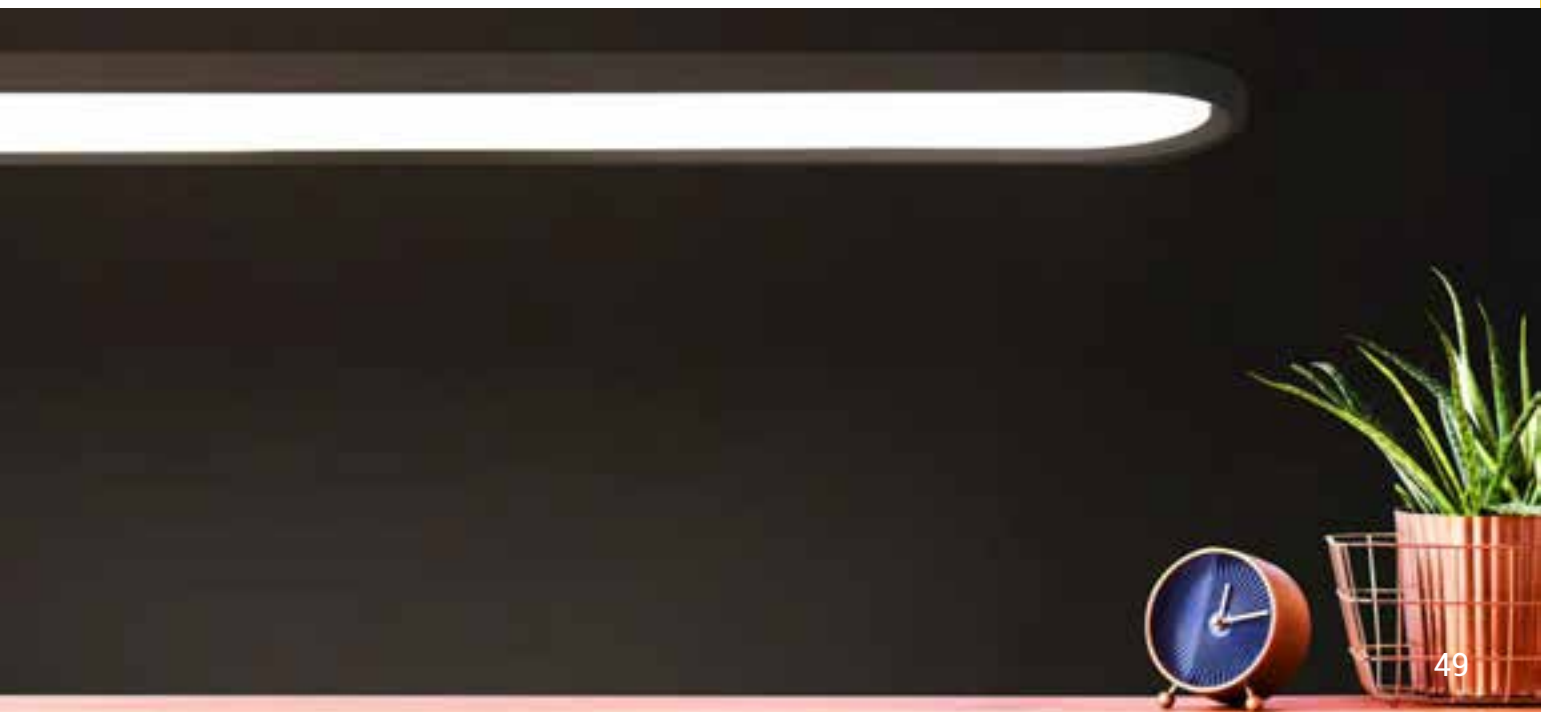



F R O N T

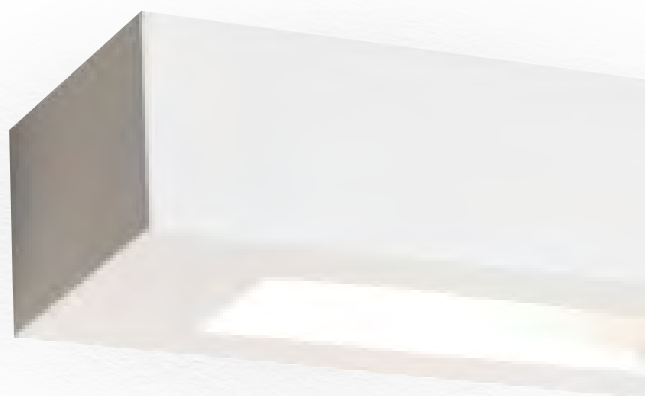

G Y P S U M





M A R T Í N





**FRONT** | EMPOTRABLE | 1x35W GU10 | máx. 250V ~50-60Hz



Y



IP  
20

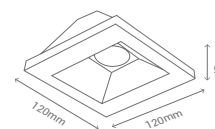

125x125mm

| REF    | W Max   |      | COLOR  |
|--------|---------|------|--------|
| 102155 | 1 x 35W | GU10 | blanco |

**FRONT** | EMPOTRABLE | 1x35W GU10 | máx. 250V ~50-60Hz



Y



IP  
20

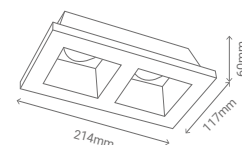

219x122mm

| REF    | W Max   |      | COLOR  |
|--------|---------|------|--------|
| 101153 | 2 x 35W | GU10 | blanco |

**FRONT** | EMPOTRABLE | 1x35W GU10 | máx. 250V ~50-60Hz



Y



IP  
20

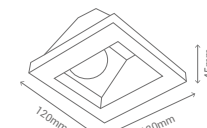

125x125mm

| REF    | W Max   |      | COLOR  |
|--------|---------|------|--------|
| 101156 | 1 x 35W | GU10 | blanco |

**FRONT** | EMPOTRABLE | 1x35W GU10 | máx. 250V ~50-60Hz



Y



IP  
20

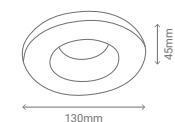

ø135mm

| REF    | W Max   |      | COLOR  |
|--------|---------|------|--------|
| 101151 | 1 x 35W | GU10 | blanco |



**FRONT** | EMPOTRABLE | 1x50W AR11 | máx. 250V ~50-60Hz



IP 20

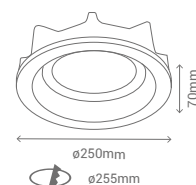

| REF    | W Max   |      | COLOR  |
|--------|---------|------|--------|
| 102151 | 1 x 50W | AR11 | blanco |

**FRONT** | EMPOTRABLE | 1x50W AR11 | máx. 250V ~50-60Hz



IP 20

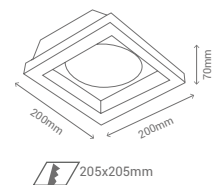

| REF    | W Max   |      | COLOR  |
|--------|---------|------|--------|
| 102152 | 1 x 50W | AR11 | blanco |

**FRONT** | EMPOTRABLE | 2x50W AR11 | máx. 250V ~50-60Hz



IP 20

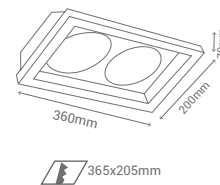

| REF    | W Max   |      | COLOR  |
|--------|---------|------|--------|
| 102153 | 2 x 50W | AR11 | blanco |



**MARTÍN** | BAÑADOR | 70x120mm | 220-240V ~50-60Hz

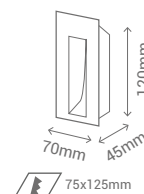

| REF    | COLOR  |
|--------|--------|
| 111624 | blanco |

**MARTÍN** | BAÑADOR | 115x55mm | 220-240V ~50-60Hz

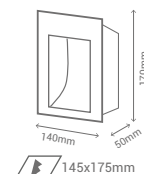

| REF    | COLOR  |
|--------|--------|
| 111621 | blanco |

**MARTÍN** | BAÑADOR | 170x50mm | 220-240V ~50-60Hz

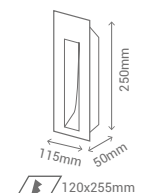

| REF    | COLOR  |
|--------|--------|
| 111620 | blanco |

**MARTÍN** | MÓDULO | SMD 2W | 220-240V ~50-60Hz

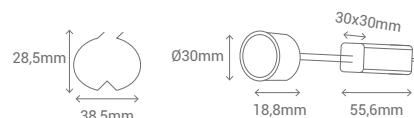

| REF    | CCT   | LM  | COLOR       |
|--------|-------|-----|-------------|
| 111608 | 2700K | 160 | plata/negro |
| 111609 | 4000K | 180 | plata/negro |







**GYPSUM** | APLIQUE | 1x25W G9 | máx. 250V ~50-60Hz



Y

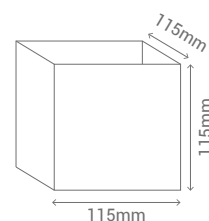

| REF    | W Máx.  |    | COLOR  |
|--------|---------|----|--------|
| 215112 | 1 x 25W | G9 | blanco |

**GYPSUM** | APLIQUE | 1x40W E14 | máx. 250V ~50-60Hz



Y

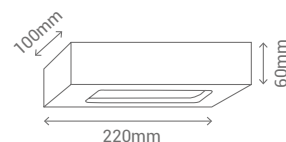

| REF    | W Máx.  |     | COLOR  |
|--------|---------|-----|--------|
| 215005 | 1 x 40W | E14 | blanco |

**GYPSUM** | APLIQUE | 1x40W E14 | máx. 250V ~50-60Hz



Y

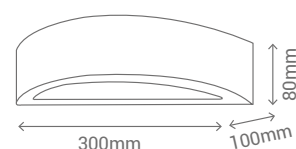

| REF    | W Máx.  |     | COLOR  |
|--------|---------|-----|--------|
| 215009 | 1 x 40W | E14 | blanco |



# VINTAGE





**VINTAGE | COLGANTE | 1x40W E27 | máx. 250V ~50-60Hz**

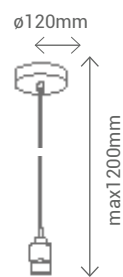

M



| REF    | W Max   | E27 | COLOR              |
|--------|---------|-----|--------------------|
| 189002 | 1 x 40W | E27 | cromo oscuro/metal |
| 189003 | 1 x 40W | E27 | cobre mate         |
| 189024 | 1 x 40W | E27 | cromo oscuro/metal |
| 189029 | 1 x 40W | E27 | cobre mate         |
| 189030 | 1 x 40W | E27 | cromo              |
| 189033 | 1 x 40W | E27 | cuero viejo/ negro |

**CUERDA | COLGANTE | 1x40W E27 | máx. 250V ~50-60Hz**

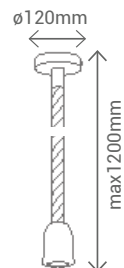

C



| REF    | W Max   | E27 | COLOR  |
|--------|---------|-----|--------|
| 189100 | 1 x 40W | E27 | marrón |

TOUCH  
HAWKING  
ASSSER



**TOUCH | FLEXO | SMD 8W** | 100 - 240V ~50-60Hz

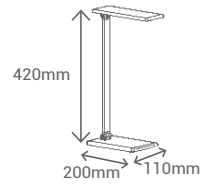

M + A



| REF    | CCT        | LM  | COLOR       |
|--------|------------|-----|-------------|
| 982137 | 2700-6500K | 462 | gris oscuro |
| 982138 | 2700-6500K | 462 | dorado      |
| 982139 | 2700-6500K | 462 | plata       |

**HAWKING | FLEXO | SMD 8W** | 100 - 240V ~50-60Hz



A



| REF    | CCT        | LM  | COLOR  |
|--------|------------|-----|--------|
| 982136 | 5500-6000K | 450 | blanco |

**ASSER | FLEXO | SMD 6,6W** | 100 - 240V ~50-60Hz

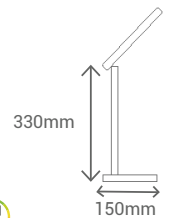

A



| REF    | CCT        | LM  | COLOR  |
|--------|------------|-----|--------|
| 982006 | 2800-5500K | 240 | blanco |

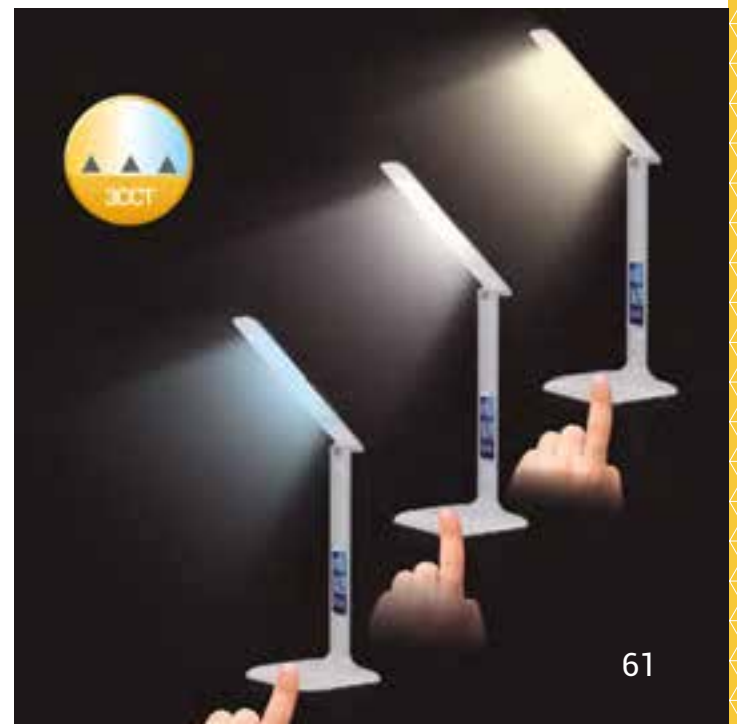

B E D  
R E A D



**BED** | APLIQUE | SMD 3W | 90 - 260V ~50-60Hz

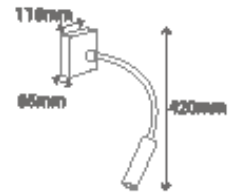

M + S



| REF    | CCT   | LM  | COLOR  |
|--------|-------|-----|--------|
| 166394 | 3000K | 270 | negro  |
| 166395 | 3000K | 270 | blanco |

**READ** | APLIQUE | SMD 5W | 220 - 240V ~50-60Hz

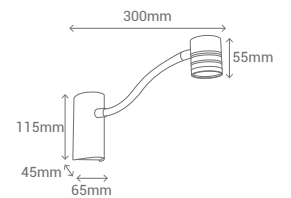

M



| REF    | CCT   | LM  | COLOR  |
|--------|-------|-----|--------|
| 101859 | 3000K | 350 | níquel |



# LIENZ





LIENZ | APLIQUE | SMD 6+3,5W | 220 - 240V ~50-60Hz



M + AL

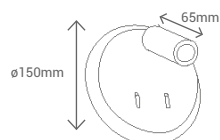

| REF    | CCT   | LM       | COLOR  |
|--------|-------|----------|--------|
| 217250 | 3000K | 360 +210 | blanco |



GUERTY  
ARM



GUERTY | APLIQUES | 1x40W E14 | máx. 250V ~50-60Hz

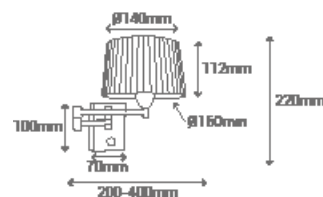

| REF    | W Max   | Base | COLOR              |
|--------|---------|------|--------------------|
| 166353 | 1 x 40W | E14  | níquel mate/blanco |
| 166356 | 1 x 40W | E14  | cuero viejo/blanco |
| 166358 | 1 x 40W | E14  | blanco/blanco      |
| 166376 | 1 x 40W | E14  | cuero viejo/crema  |

GUERTY | APLIQUES | 1x60W E14 | máx. 250V ~50-60Hz

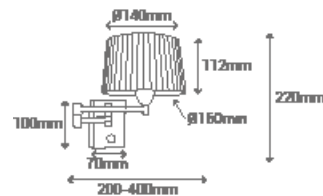

| REF    | W Max   | Base | COLOR         |
|--------|---------|------|---------------|
| 166380 | 1 x 60W | E14  | chromo/blanco |

ARM | APLIQUE | SMD 1W + 1x60W E27 | 220 - 240V ~50-60Hz

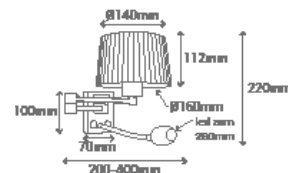

| REF    | CCT   | LM | Base | COLOR         |
|--------|-------|----|------|---------------|
| 166390 | 3000K | 80 | E27  | chromo/blanco |



# LOLA



LOLA | APLIQUE | SMD 1W + 1x60W E27 | 220-240V ~50-60Hz



| REF    | CCT   | LM | W   | COLOR              |
|--------|-------|----|-----|--------------------|
| 166392 | 3000K | 80 | E27 | chromo/blanco      |
| 166393 | 3000K | 80 | E27 | cuero viejo/blanco |





# EPSILON



EPSILON | COLGANTE | 1x60W E27 | máx. 250V ~50-60Hz

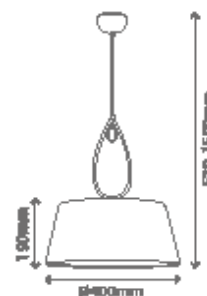

| REF    | W Max   | Symbol | COLOR         |
|--------|---------|--------|---------------|
| 361010 | 1 x 60W | E27    | chromo/blanco |

EPSILON | COLGANTE | 3x40W E14 | máx. 250V ~50-60Hz

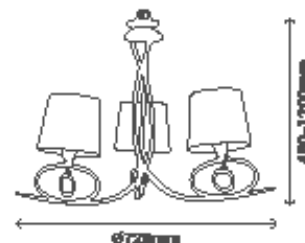

| REF    | W Max   | Symbol | COLOR         |
|--------|---------|--------|---------------|
| 361030 | 3 x 40W | E14    | chromo/blanco |

EPSILON | COLGANTE | 5x40W E14 | máx. 250V ~50-60Hz

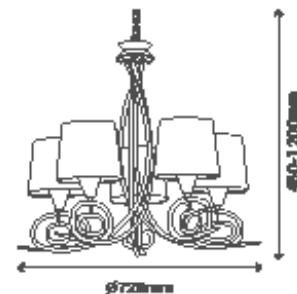

| REF    | W Max   | Symbol | COLOR         |
|--------|---------|--------|---------------|
| 361050 | 5 x 40W | E14    | chromo/blanco |





# K A H O Y



KAHOY | PIE DE SALÓN | SMD 30 + 6W | 220-240V ~50-60Hz

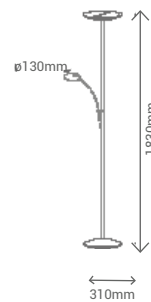

M + AC



| REF    | CCT   | LM         | COLOR        |
|--------|-------|------------|--------------|
| 982359 | 3000K | 2300 + 400 | blanco/cromo |



# A R O N



ARON | PIE DE SALÓN | SMD 20 + 5W | 220-240V ~50-60Hz

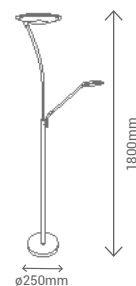

M + G + AC



| REF    | CCT   | LM         | COLOR       |
|--------|-------|------------|-------------|
| 982375 | 3000K | 1600 + 400 | níquel      |
| 982376 | 3000K | 1600 + 400 | cuero viejo |



# NORCIA



**NORCIA** | PIE DE SALÓN | 1x60W E27 | máx. 250V ~50-60Hz

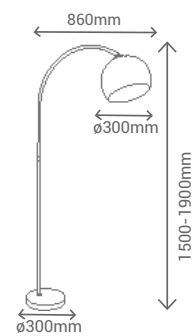

M + AC

IP 20

| REF    | W Max   |     | COLOR         |
|--------|---------|-----|---------------|
| 982740 | 1 x 60W | E27 | chromo/blanco |



# B A S I C









**BASIC | PANTALLA | PIE - COLGANTE**

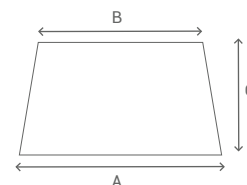

| REF    | A   | B   | C   | COLOR  |
|--------|-----|-----|-----|--------|
| 263120 | 400 | 350 | 220 | blanco |
| 263121 | 400 | 350 | 220 | negro  |
| 263122 | 400 | 350 | 220 | gris   |
| 263123 | 400 | 350 | 220 | marrón |
| 263124 | 400 | 350 | 220 | crema  |
| 263110 | 500 | 450 | 250 | blanco |
| 263111 | 500 | 450 | 250 | negro  |
| 263112 | 500 | 450 | 250 | gris   |
| 263113 | 500 | 450 | 250 | marrón |
| 263114 | 500 | 450 | 250 | crema  |

**BASIC | COLGANTE | 1x60W E27 | máx. 250V ~50-60Hz**

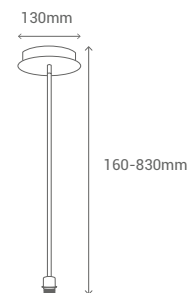

| REF    | W Max   | ⚡   | COLOR  |
|--------|---------|-----|--------|
| 224410 | 1 x 60W | E27 | marrón |
| 224412 | 1 x 60W | E27 | blanco |
| 224416 | 1 x 60W | E27 | cromo  |

\*Pantalla no incluida / Lamp shades not included / Abat-jour non inclus / Abat-jour não incluído.

**BASIC | PIE DE SALÓN | 1x60W E27 | máx. 250V ~50-60Hz**



| REF    | W Max   | ⚡   | COLOR  |
|--------|---------|-----|--------|
| 224510 | 1 x 60W | E27 | marrón |
| 224512 | 1 x 60W | E27 | blanco |
| 224516 | 1 x 60W | E27 | cromo  |

\*Pantalla no incluida / Lamp shades not included / Abat-jour non inclus / Abat-jour não incluído.

**BASIC** | PANTALLA | SOBREMESA

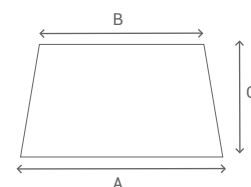

| REF    | A   | B   | C   | COLOR  |
|--------|-----|-----|-----|--------|
| 263130 | 300 | 250 | 200 | blanco |
| 263131 | 300 | 250 | 200 | negro  |
| 263132 | 300 | 250 | 200 | gris   |
| 263133 | 300 | 250 | 200 | marrón |
| 263134 | 300 | 250 | 200 | crema  |

**BASIC** | SOBREMESA | 1x60W E27 | máx. 250V ~50-60Hz

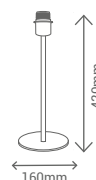

| REF    | W Max   | Socket | COLOR  |
|--------|---------|--------|--------|
| 224040 | 1 x 60W | E27    | marrón |
| 224042 | 1 x 60W | E27    | blanco |
| 224046 | 1 x 60W | E27    | cromo  |

\*Pantalla no incluida / Lamp shades not included / Abat-jour non inclus / Abat-jour não incluído.



**BASIC | PANTALLA | APLIQUE - SOBREMESA**

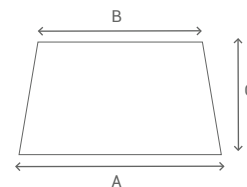

| REF    | A   | B   | C   | COLOR  |
|--------|-----|-----|-----|--------|
| 263100 | 180 | 160 | 110 | blanco |
| 263101 | 180 | 160 | 110 | negro  |
| 263102 | 180 | 160 | 110 | gris   |
| 263103 | 180 | 160 | 110 | marrón |
| 263104 | 180 | 160 | 110 | crema  |

**BASIC | SOBREMESA | 1x60W E27 | máx. 250V ~50-60Hz**

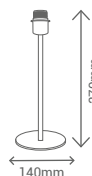

| REF    | W Max   | Socket | COLOR  |
|--------|---------|--------|--------|
| 224010 | 1 x 60W | E27    | marrón |
| 224012 | 1 x 60W | E27    | blanco |
| 224016 | 1 x 60W | E27    | chromo |

\*Pantalla no incluida / Lamp shades not included / Abat-jour non inclus / Abat-jour não incluído.

**BASIC | APLIQUE | 1x60W E27 | máx. 250V ~50-60Hz**

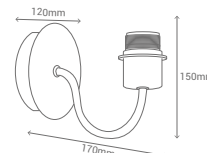

| REF    | W Max   | Socket | COLOR  |
|--------|---------|--------|--------|
| 224310 | 1 x 60W | E27    | marrón |
| 224312 | 1 x 60W | E27    | blanco |
| 224316 | 1 x 60W | E27    | chromo |

\*Pantalla no incluida / Lamp shades not included / Abat-jour non inclus / Abat-jour não incluído.

**BASIC | APLIQUE | 1x60W E14 | máx. 250V ~50-60Hz**

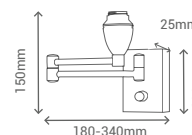

| REF    | W Max   | Socket | COLOR            |
|--------|---------|--------|------------------|
| 166310 | 1 x 60W | E14    | marrón           |
| 166312 | 1 x 60W | E14    | blanco brocheado |
| 166318 | 1 x 60W | E14    | blanco           |
| 166319 | 1 x 60W | E14    | chromo           |

\*Pantalla no incluida / Lamp shades not included / Abat-jour non inclus / Abat-jour não incluído.

**BASIC | PANTALLA | APLIQUE - SOBREMESA**

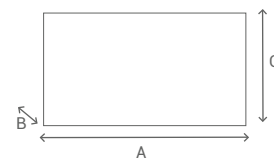

| REF    | A   | B   | C   | COLOR  |
|--------|-----|-----|-----|--------|
| 263140 | 300 | 100 | 200 | blanco |
| 263141 | 300 | 100 | 200 | negro  |
| 263142 | 300 | 100 | 200 | gris   |
| 263143 | 300 | 100 | 200 | marrón |
| 263144 | 300 | 100 | 200 | crema  |

**BASIC | APLIQUE | 2x60W E27 | máx. 250V ~50-60Hz**

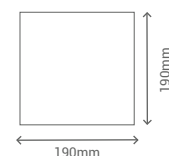

| REF   | W Max   | Socket | COLOR  |
|-------|---------|--------|--------|
| 60500 | 2 x 60W | E27    | blanco |

\*Pantalla no incluida / Lamp shades not included / Abat-jour non inclus / Abat-jour não incluído.



# CARRY



MONOFASICO

CARRY | MONOFASICO | COB 3x8W | 220-240V ~50-60Hz

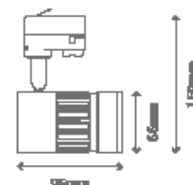

AL



| REF    | CCT   | LM  | COLOR  |
|--------|-------|-----|--------|
| 112080 | 3000K | 550 | blanco |
| 112081 | 3000K | 550 | gris   |





# FULINO



**FULINO** | APLIQUE | SMD 1x10W | 100-240V ~50-60Hz

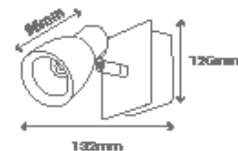

AL



| REF    | CCT   | LM  | COLOR  |
|--------|-------|-----|--------|
| 112230 | 4000K | 800 | blanco |

**FULINO** | APLIQUE | SMD 2x10W | 100-240V ~50-60Hz



AL



| REF    | CCT   | LM   | COLOR  |
|--------|-------|------|--------|
| 112228 | 4000K | 1600 | blanco |

**FULINO** | APLIQUE | SMD 3x10W | 100-240V ~50-60Hz

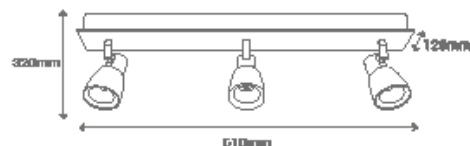

AL



| REF    | CCT   | LM   | COLOR  |
|--------|-------|------|--------|
| 112226 | 4000K | 2400 | blanco |



P O L O N



**POLON** | APLIQUE | SMD 1x5W | 220-240V ~50-60Hz

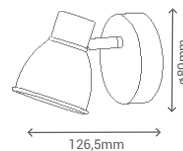

| REF    | CCT   | LM  | COLOR       |
|--------|-------|-----|-------------|
| 189039 | 4000K | 270 | cuero viejo |

**POLON** | APLIQUE | SMD 2x5W | 220-240V ~50-60Hz

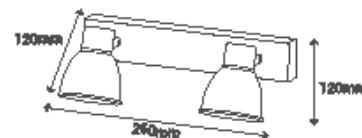

| REF    | CCT   | LM  | COLOR       |
|--------|-------|-----|-------------|
| 189096 | 4000K | 540 | cuero viejo |

**POLON** | APLIQUE | SMD 3x5W | 220-240V ~50-60Hz

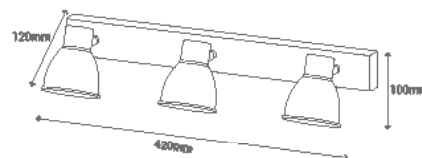

| REF    | CCT   | LM  | COLOR       |
|--------|-------|-----|-------------|
| 189046 | 4000K | 810 | cuero viejo |



# K O D Y



**KODY | APLIQUE | SMD 1x5W GU10 | 220-240V ~50-60Hz**

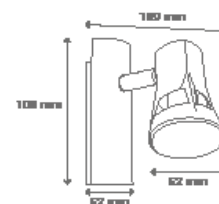

| REF    | W Max   | ↓    | COLOR       |
|--------|---------|------|-------------|
| 216000 | 1 x 40W | GU10 | níquel      |
| 216003 | 1 x 40W | GU10 | cuero viejo |

**KODY | APLIQUE | SMD 2x5W GU10 | 220-240V ~50-60Hz**

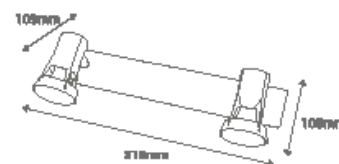

| REF    | W Max   | ↓    | COLOR       |
|--------|---------|------|-------------|
| 216001 | 2 x 40W | GU10 | níquel      |
| 216004 | 2 x 40W | GU10 | cuero viejo |

**KODY | APLIQUE | SMD 3x5W GU10 | 220-240V ~50-60Hz**

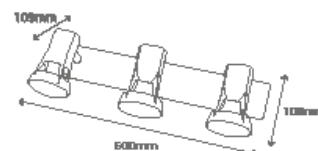

| REF    | W Max   | ↓    | COLOR       |
|--------|---------|------|-------------|
| 216002 | 3 x 40W | GU10 | níquel      |
| 216005 | 3 x 40W | GU10 | cuero viejo |

**KODY | APLIQUE | SMD 4x5W GU10 | 220-240V ~50-60Hz**

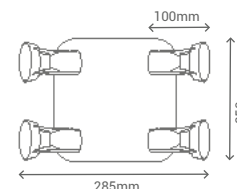

| REF    | W Max   | ↓    | COLOR       |
|--------|---------|------|-------------|
| 216007 | 4 x 40W | GU10 | níquel      |
| 216008 | 4 x 40W | GU10 | cuero viejo |



NATURE





NATURE | APLIQUE | SMD 1x5W | 100-240V ~50-60Hz

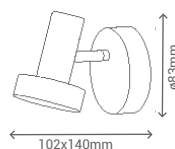

| REF    | CCT   | LM  | COLOR              |
|--------|-------|-----|--------------------|
| 189048 | 4000K | 270 | cuero viejo/madera |

NATURE | APLIQUE | SMD 2x5W | 100-240V ~50-60Hz

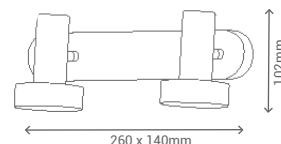

| REF    | CCT   | LM  | COLOR              |
|--------|-------|-----|--------------------|
| 189049 | 3000K | 540 | cuero viejo/madera |

NATURE | APLIQUE | SMD 3x5W | 100-240V ~50-60Hz

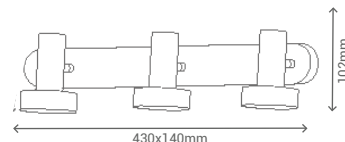

| REF    | CCT   | LM  | COLOR              |
|--------|-------|-----|--------------------|
| 189050 | 4000K | 810 | cuero viejo/madera |



# K L E E



**KLEE | APLIQUE | SMD 12W | 220-240V ~50-60Hz**



AL



| REF    | CCT   | LM  | COLOR  |
|--------|-------|-----|--------|
| 217010 | 3000K | 720 | blanco |

**KLEE | APLIQUE | SMD 16W | 220-240V ~50-60Hz**



AL



| REF    | CCT   | LM  | COLOR              |
|--------|-------|-----|--------------------|
| 217020 | 3000K | 960 | aluminio brocheado |
| 217011 | 3000K | 960 | blanco             |

**KLEE | APLIQUE | SMD 24W | 220-240V ~50-60Hz**



AL



| REF    | CCT   | LM   | COLOR  |
|--------|-------|------|--------|
| 217012 | 3000K | 1400 | blanco |



# SELMA

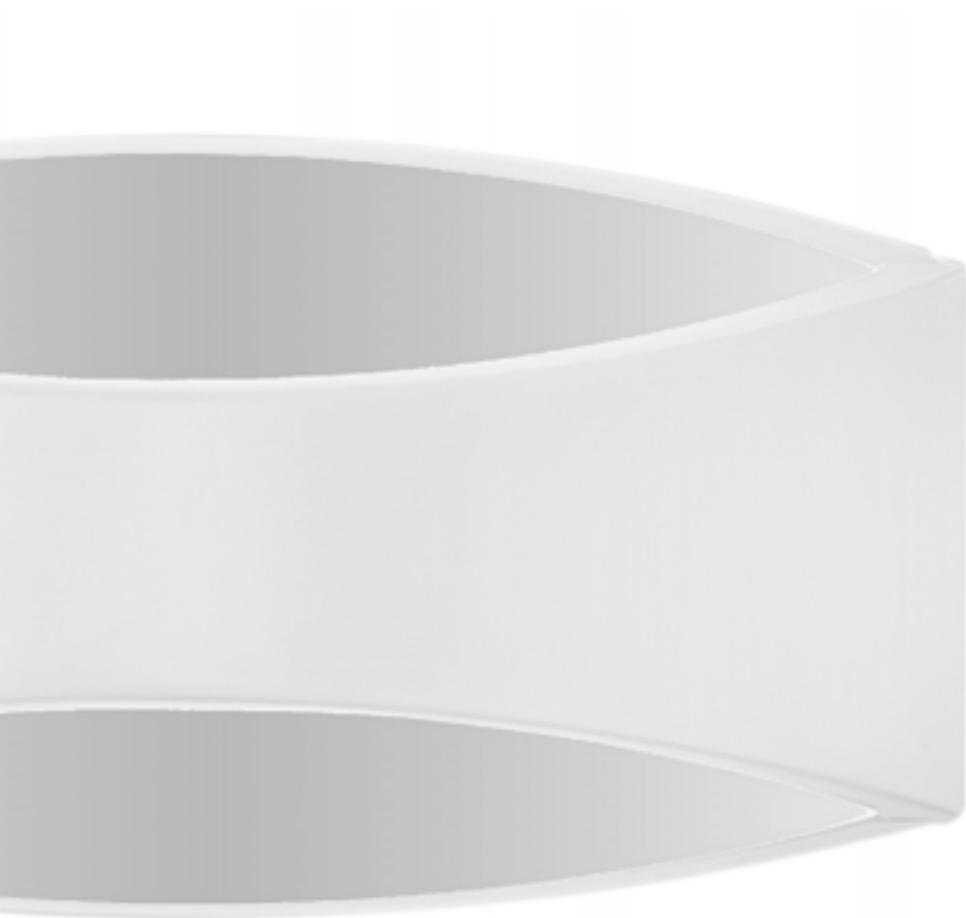

SELMA | APLIQUE | SMD 8W | 100-240V ~50-60Hz

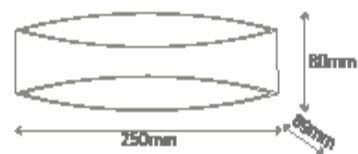

AL



| REF    | CCT   | LM  | COLOR  |
|--------|-------|-----|--------|
| 217000 | 3000K | 600 | blanco |



# M O R A N



**MORAN** | APLIQUE | **SMD 12W** | 100-240V ~50-60Hz



AL

20.000h

U<sub>E</sub>-5~  
+40°C

Ψ  
PF 0.80

IP  
20

180°

A+

CRI  
80

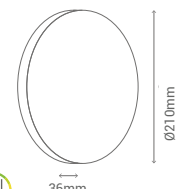

| REF    | CCT   | LM  | COLOR  |
|--------|-------|-----|--------|
| 217200 | 3000K | 900 | blanco |

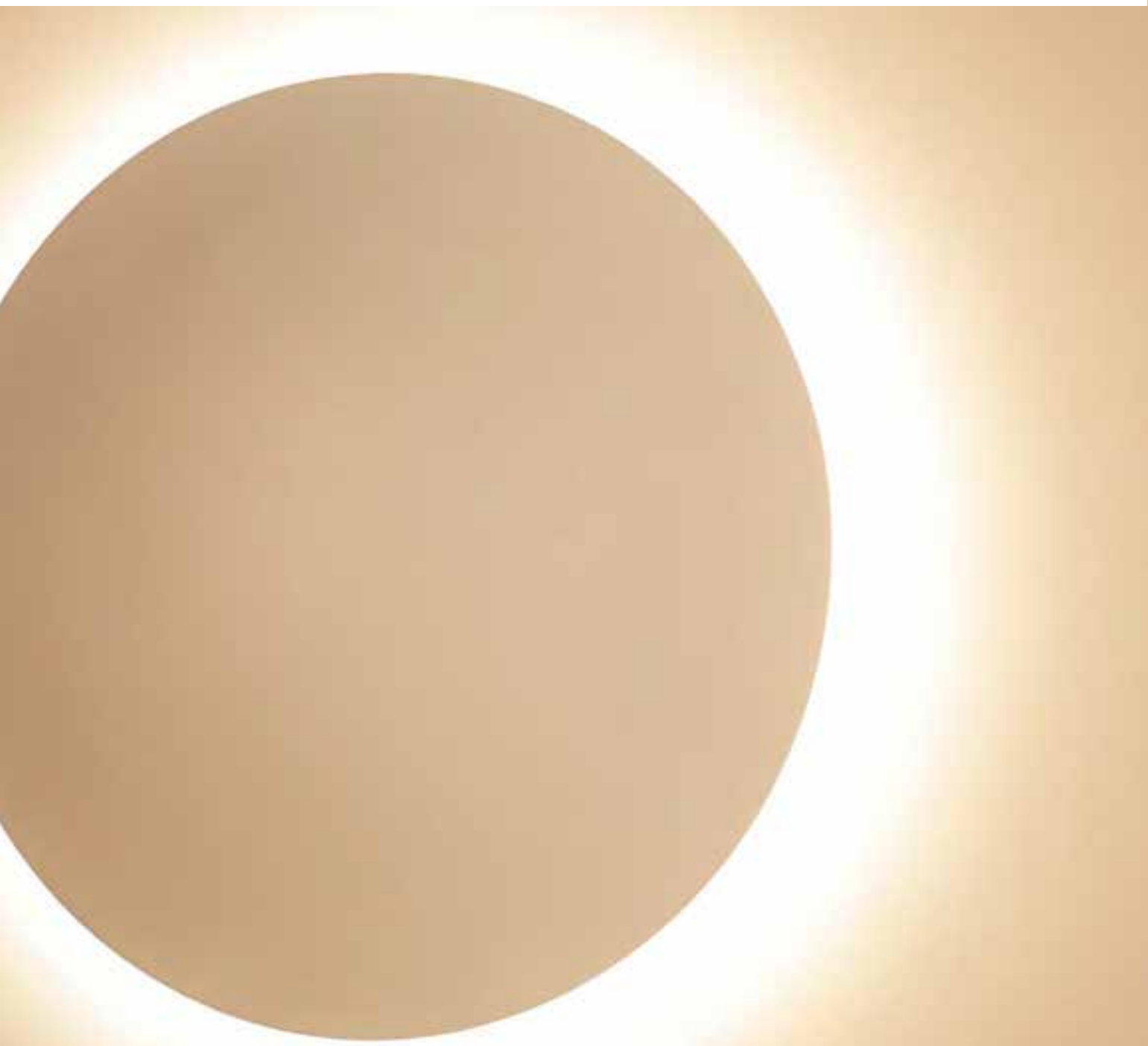



CURLY



CURLY | APLIQUE | SMD 8W | 230V ~50-60Hz

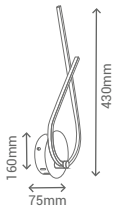

| REF    | CCT   | LM  | COLOR  |
|--------|-------|-----|--------|
| 166720 | 3000K | 640 | níquel |



# DEVIS

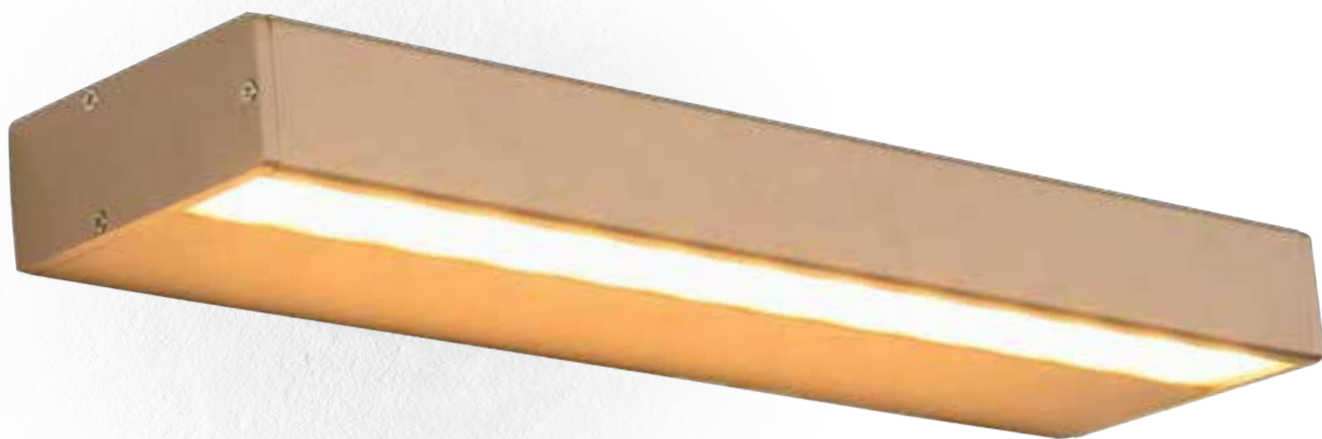

DEVIS | APLIQUE | SMD 12W | 110-240V ~50-60Hz



AL



| REF    | CCT   | LM   | COLOR  |
|--------|-------|------|--------|
| 217170 | 3000K | 1000 | blanco |
| 217175 | 3000K | 1000 | negro  |
| 217180 | 3000K | 1000 | bronce |



# W A L L



**WALL | APLIQUE | 1x60W E27 |** máx. 250V ~50-60Hz



M + G

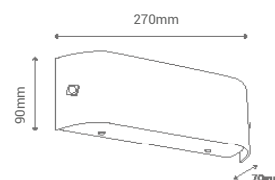

| REF    | W Max   |     | COLOR                   |
|--------|---------|-----|-------------------------|
| 284310 | 1 x 60W | E27 | blanco satinado / cromo |

**WALL | APLIQUE | 2x60W E27 |** máx. 250V ~50-60Hz



M + G

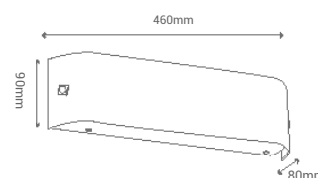

| REF    | W Max   |     | COLOR                   |
|--------|---------|-----|-------------------------|
| 284350 | 2 x 60W | E27 | blanco satinado / cromo |



HUNT  
DRAPER





**HUNT** | APLIQUE | **SMD 6W** | 100-240V ~50-60Hz

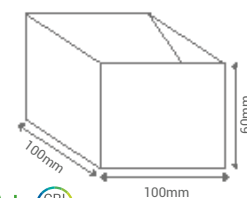

AL



| REF    | CCT   | LM  | COLOR  |
|--------|-------|-----|--------|
| 217150 | 3000K | 400 | blanco |

**DRAPER** | APLIQUE | **SMD 15W** | 220-240V ~50-60Hz



AL



| REF    | CCT   | LM  | COLOR  |
|--------|-------|-----|--------|
| 217105 | 3000K | 900 | blanco |



# FACTORY



FACTORY | APLIQUE | 1x40W E27 | máx. 250V ~50-60Hz



M



| REF    | W Max   | Symbol | COLOR   |
|--------|---------|--------|---------|
| 229300 | 1 x 40W | E27    | oxidado |

FACTORY | COLGANTE | 1x40W E27 | máx. 250V ~50-60Hz

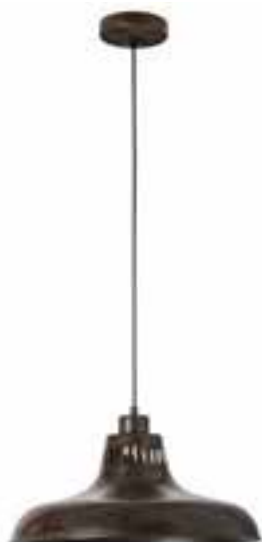

M

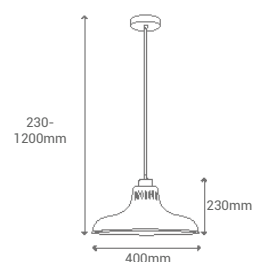

| REF    | W Max   | Symbol | COLOR   |
|--------|---------|--------|---------|
| 229000 | 1 x 40W | E27    | oxidado |



# NAVY

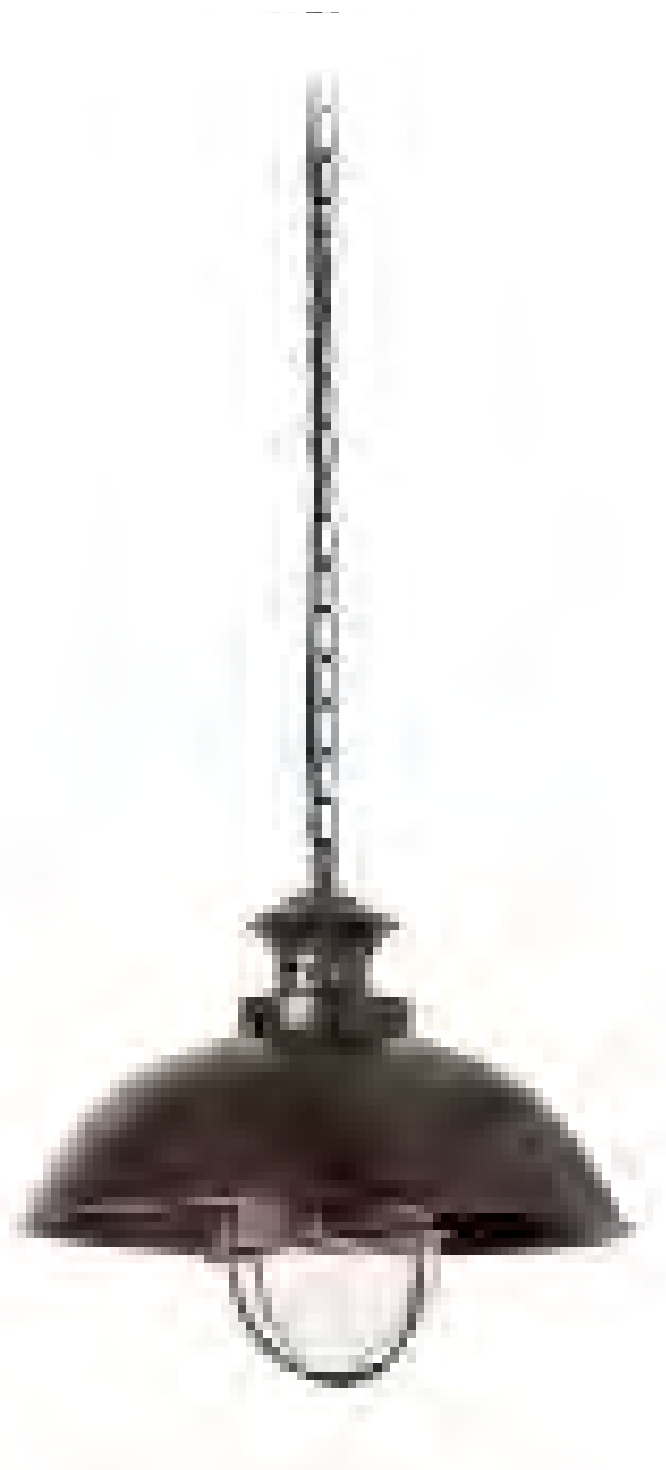

NAVY | APLIQUE | 1x60W E27 | máx. 250V ~50-60Hz

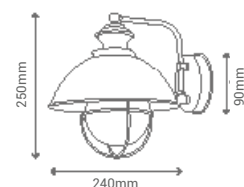

| REF    | W Max   |     | COLOR   |
|--------|---------|-----|---------|
| 229100 | 1 x 40W | E27 | oxidado |

NAVY | COLGANTE | 1x40W E27 | máx. 250V ~50-60Hz

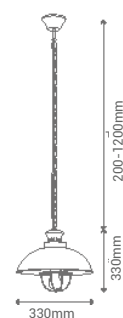

| REF    | W Max   |     | COLOR   |
|--------|---------|-----|---------|
| 229200 | 1 x 40W | E27 | oxidado |



A R E N A D O  
L Á G R I M A S





**ARENADO** | PLAFÓN | 2x60W E27 | máx. 250V ~50-60Hz



M + G



| REF    | W Max   | Socket | COLOR          |
|--------|---------|--------|----------------|
| 982036 | 2 x 60W | E27    | blanco / cromo |

**LÁGRIMAS** | PLAFÓN | 2x60W E27 | máx. 250V ~50-60Hz

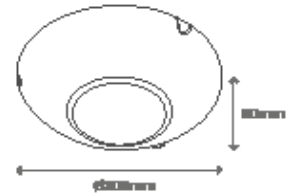

M + G



| REF    | W Max   | Socket | COLOR                 |
|--------|---------|--------|-----------------------|
| 278348 | 2 x 60W | E27    | blanco / transparente |

**LÁGRIMAS** | PLAFÓN | 3x60W E27 | máx. 250V ~50-60Hz

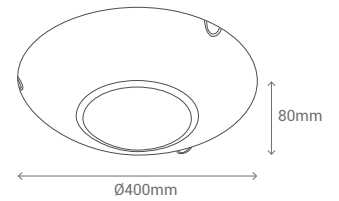

M + G



| REF    | W Max   | Socket | COLOR                 |
|--------|---------|--------|-----------------------|
| 278349 | 3 x 60W | E27    | blanco / transparente |





# FLAT



**FLAT | PLAFÓN | 2x60W E27 |** máx. 250V ~50-60Hz



M + G



| REF    | W Max   |     | COLOR                 |
|--------|---------|-----|-----------------------|
| 279130 | 2 x 60W | E27 | blanco / transparente |

**FLAT | PLAFÓN | 3x60W E27 |** máx. 250V ~50-60Hz



M + G



| REF    | W Max   |     | COLOR                 |
|--------|---------|-----|-----------------------|
| 279140 | 3 x 60W | E27 | blanco / transparente |



# T A F L A



**TAFLA** | ILUMINACUADROS | **SMD 12W** | 220-240V ~50-60Hz



| REF    | CCT   | LM   | COLOR  |
|--------|-------|------|--------|
| 141430 | 4000K | 1000 | níquel |



# PICABIA



**PICABIA** | ILUMINACUADROS | **SMD 8W** | 220-240V ~50-60Hz



| REF    | CCT   | LM  | COLOR  |
|--------|-------|-----|--------|
| 141291 | 4000K | 310 | chromo |

**PICABIA** | ILUMINACUADROS | **SMD 12W** | 220-240V ~50-60Hz



| REF    | CCT   | LM  | COLOR  |
|--------|-------|-----|--------|
| 141281 | 4000K | 532 | chromo |



# BARGELD





**BARGELD | ILUMINACUADROS | SMD 8W | 90-264V ~50-60Hz**

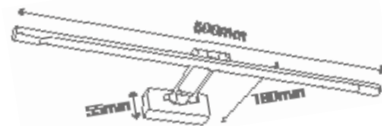

M + AC



| REF    | CCT   | LM  | COLOR  |
|--------|-------|-----|--------|
| 141280 | 4000K | 310 | chromo |

**BARGELD | ILUMINACUADROS | SMD 12W | 220-240V ~50-60Hz**

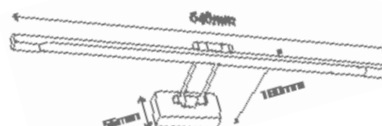

M + AC



| REF    | CCT   | LM  | COLOR  |
|--------|-------|-----|--------|
| 141290 | 4000K | 800 | chromo |



# CENEFA



## CENEFA | SOBREMESA | 1x60W E14 | máx. 250V ~50-60Hz

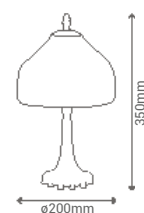

| REF    | W Max   |     | COLOR      |
|--------|---------|-----|------------|
| 400412 | 1 x 60W | E14 | multicolor |

## CENEFA | COLGANTE | 3x60W E27 | máx. 250V ~50-60Hz

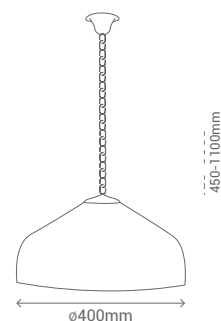
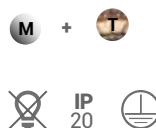

| REF    | W Max   |     | COLOR      |
|--------|---------|-----|------------|
| 400034 | 3 x 60W | E27 | multicolor |



# VIDRIERA



**VIDRIERA** | SOBREMESA | 1x60W E14 | máx. 250V ~50-60Hz

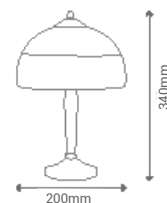

| REF  | W Max   |     | COLOR      |
|------|---------|-----|------------|
| 4559 | 1 x 60W | E14 | multicolor |

**VIDRIERA** | SOBREMESA | 1x60W E27 | máx. 250V ~50-60Hz

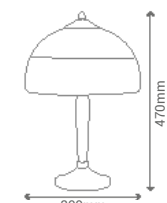

| REF  | W Max   |     | COLOR      |
|------|---------|-----|------------|
| 4556 | 1 x 60W | E27 | multicolor |

**VIDRIERA** | COLGANTE | 3x60W E27 | máx. 250V ~50-60Hz

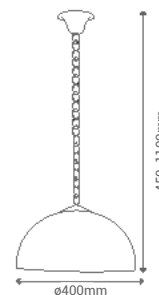
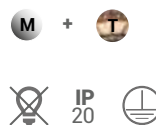

| REF  | W Max   |     | COLOR      |
|------|---------|-----|------------|
| 4552 | 3 x 60W | E27 | multicolor |



## TORTUGA



**TORTUGA** | SOBREMESA | 1x25W E14 | máx. 250V ~50-60Hz



| REF    | W Max   |     | COLOR      |
|--------|---------|-----|------------|
| 405411 | 1 x 25W | E14 | multicolor |



# E B R O



**EBRO** | SOBREMESA | 1x60W E14 | máx. 250V ~50-60Hz

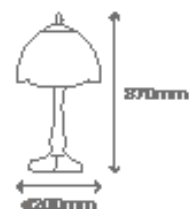
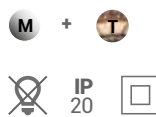

| REF  | W Max   | Shield | COLOR      |
|------|---------|--------|------------|
| 8759 | 1 x 60W | E14    | multicolor |

**EBRO** | APLIQUE | 1x60W E27 | máx. 250V ~50-60Hz

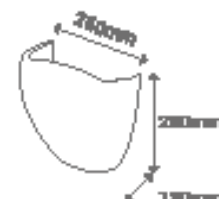

| REF  | W Max   | Shield | COLOR      |
|------|---------|--------|------------|
| 8758 | 1 x 60W | E27    | multicolor |

**EBRO** | COLGANTE | 3x60W E27 | máx. 250V ~50-60Hz

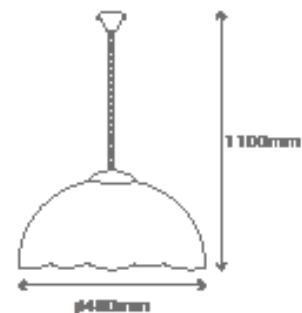
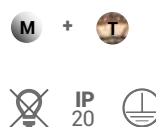

| REF  | W Max   | Shield | COLOR      |
|------|---------|--------|------------|
| 8752 | 3 x 60W | E27    | multicolor |



# NAOMI



**NAOMI** | SOBREMESA | 1x60W E14 | máx. 250V ~50-60Hz

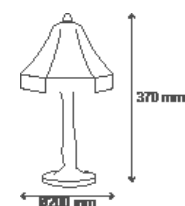

| REF    | W Max   |     | COLOR      |
|--------|---------|-----|------------|
| 912490 | 1 x 60W | E14 | multicolor |

**NAOMI** | APLIQUE | 1x60W E14 | máx. 250V ~50-60Hz

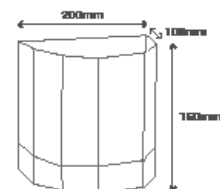

| REF    | W Max   |     | COLOR      |
|--------|---------|-----|------------|
| 912310 | 1 x 60W | E14 | multicolor |

**NAOMI** | COLGANTE | 1x60W E27 | máx. 250V ~50-60Hz

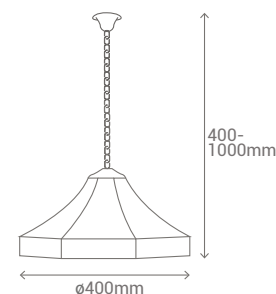
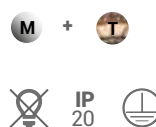

| REF    | W Max   |     | COLOR      |
|--------|---------|-----|------------|
| 912040 | 1 x 60W | E27 | multicolor |



# J O K K M O K K



JOKKMOKK | SOBREMESA | SMD 7W | 100-240V ~50-60Hz



M + AL + AC

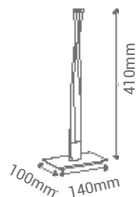

| REF    | CCT   | LM  | COLOR  |
|--------|-------|-----|--------|
| 167102 | 4000K | 500 | chromo |

JOKKMOKK | PIE DE SALÓN | SMD 28W | 220-240V ~50-60Hz



M + AL + AC

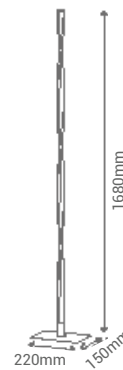

| REF    | CCT   | LM   | COLOR  |
|--------|-------|------|--------|
| 167101 | 4000K | 1900 | chromo |

JOKKMOKK | COLGANTE | SMD 38W | 220-240V ~50-60Hz



M + AL + AC

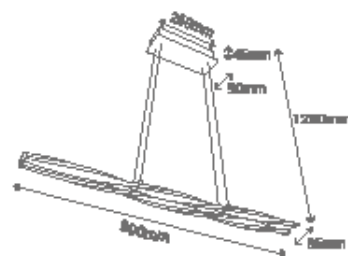

| REF    | CCT   | LM   | COLOR  |
|--------|-------|------|--------|
| 167100 | 4000K | 2650 | chromo |





# L U L E A



LULEA | SOBREMESA | SMD 7W | 100-240V ~50-60Hz



M + AL + AC



| REF    | CCT   | LM  | COLOR  |
|--------|-------|-----|--------|
| 168102 | 4000K | 500 | chromo |

LULEA | PIE DE SALÓN | SMD 28W | 220-240V ~50-60Hz



M + AL + AC



| REF    | CCT   | LM   | COLOR  |
|--------|-------|------|--------|
| 168101 | 4000K | 1900 | chromo |

LULEA | COLGANTE | SMD 38W | 220-240V ~50-60Hz



M + AL + AC

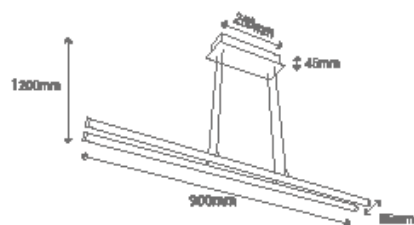

| REF    | CCT   | LM   | COLOR  |
|--------|-------|------|--------|
| 168100 | 4000K | 2650 | chromo |



HILL



DEEL



TINN



CANDY



**HILL** | SOBREMESA | 1x40W G9 | máx.250V ~50-60Hz



M + G

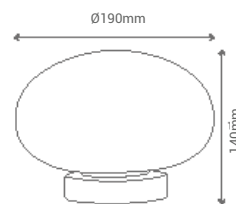

| REF    | W Max   |    | COLOR         |
|--------|---------|----|---------------|
| 266910 | 1 x 40W | G9 | blanco/níquel |

**DEEL** | SOBREMESA | 1x40W E14 | máx.250V ~50-60Hz



M + G



| REF    | W Max   |     | COLOR         |
|--------|---------|-----|---------------|
| 266920 | 1 x 40W | E14 | blanco/níquel |



**TINN** | SOBREMESA | 1x40W E14 | máx.250V ~50-60Hz



M + G

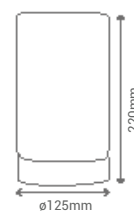

| REF    | W Max   | Socket | COLOR         |
|--------|---------|--------|---------------|
| 266925 | 1 x 40W | E14    | blanco/níquel |

**CANDY** | SOBREMESA | 1x60W E14 | máx.250V ~50-60Hz



M + G

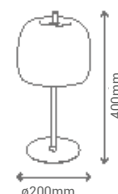

| REF    | W Max   | Socket | COLOR        |
|--------|---------|--------|--------------|
| 266901 | 1 x 60W | E14    | cromo/blanco |



# S T E R N





**STERN | COLGANTE | LED 30W | 220-240V ~50-60Hz**

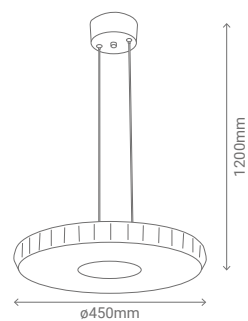

M + G

| REF    | CCT   | LM   | COLOR        |
|--------|-------|------|--------------|
| 800200 | 4000K | 2100 | Cromo/blanco |

**STERN | PLAFÓN | LED 30W | 220-240V ~50-60Hz**

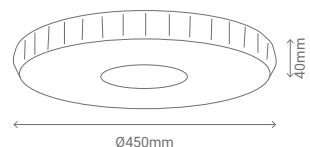

M + G

| REF    | CCT   | LM   | COLOR        |
|--------|-------|------|--------------|
| 800201 | 4000K | 2100 | Cromo/blanco |

**EFECTO ESCARCHA DE CRISTAL**  
 Diamond sand finish | Effet verre givré | Efeito geado



# KARLOFF



**KARLOFF | COLGANTE | 1x60W E27 |** máx. 250V ~50-60Hz

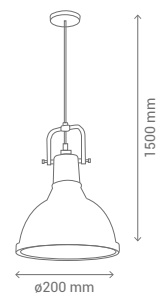

M + G



| REF    | W Máx.  |     | COLOR                        |
|--------|---------|-----|------------------------------|
| 189917 | 1 x 60W | E27 | Blanco / Negro / Cuero viejo |

**KARLOFF | APLIQUE | 1x60W E27 |** máx. 250V ~50-60Hz

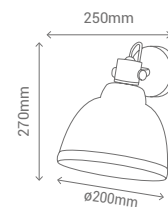

M + G



| REF    | W Máx.  |     | COLOR                        |
|--------|---------|-----|------------------------------|
| 189918 | 1 x 60W | E27 | Blanco / Negro / Cuero viejo |

**KARLOFF | PIE DE SALON | 3x60W E27 |** máx. 250V ~50-60Hz

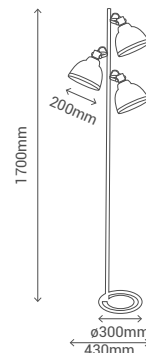

M + G



| REF    | W Máx.  |     | COLOR                        |
|--------|---------|-----|------------------------------|
| 189943 | 3 x 60W | E27 | Blanco / Negro / Cuero viejo |



# V E N U S



**VENUS** | COLGANTE | 1x60W E27 | máx.250V ~50-60Hz

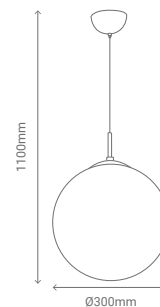

M + AC

IP 20

| REF    | W Máx. | E27 | COLOR |
|--------|--------|-----|-------|
| 261595 | 60W    | E27 | cromo |

**VENUS** | PLAFÓN | 1x60W E27 | máx.250V ~50-60Hz

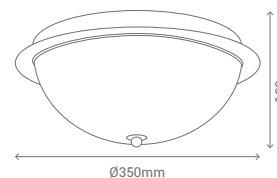

M + AC

IP 20

| REF    | W Máx. | E27 | COLOR |
|--------|--------|-----|-------|
| 261235 | 1x60W  | E27 | cromo |

**VENUS** | SOBREMESA | 1x60W E14 | máx.250V ~50-60Hz



M + AC

IP 20

| REF    | W Máx. | E27 | COLOR |
|--------|--------|-----|-------|
| 261495 | 1x60W  | E27 | cromo |



**VENUS** | APLIQUE | 1x33W G9 | máx. 250V ~50-60Hz

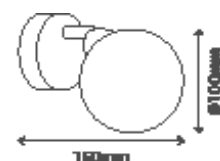

| REF    | W Máx. | ⚡  | COLOR  |
|--------|--------|----|--------|
| 209413 | 1x33W  | G9 | chromo |

**VENUS** | APLIQUE | 2x33W G9 | máx. 250V ~50-60Hz

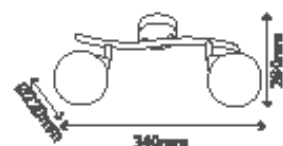

| REF    | W Máx. | ⚡  | COLOR  |
|--------|--------|----|--------|
| 209223 | 2x33W  | G9 | chromo |

**VENUS** | APLIQUE | 3x33W G9 | máx. 250V ~50-60Hz

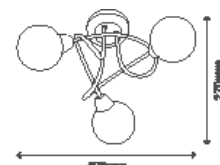

| REF    | W Máx. | ⚡  | COLOR  |
|--------|--------|----|--------|
| 209233 | 3x33W  | G9 | chromo |

**VENUS** | PLAFÓN | 4x33W G9 | máx. 250V ~50-60Hz

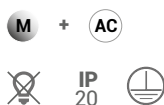

| REF    | W Máx. | ⚡  | COLOR  |
|--------|--------|----|--------|
| 209243 | 4x33W  | G9 | chromo |

**VENUS** | PLAFÓN | 4x33W G9 | máx. 250V ~50-60Hz

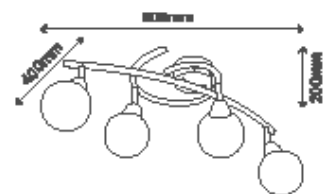

| REF    | W Máx. | ⚡  | COLOR  |
|--------|--------|----|--------|
| 209513 | 4x33W  | G9 | chromo |

**VENUS** | PLAFÓN | 6x33W G9 | máx. 250V ~50-60Hz

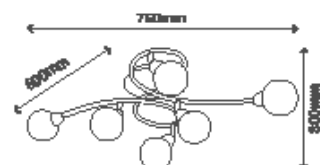

| REF    | W Máx. | ⚡  | COLOR  |
|--------|--------|----|--------|
| 209613 | 6x33W  | G9 | chromo |





TECHNICAL





# DOTFIX

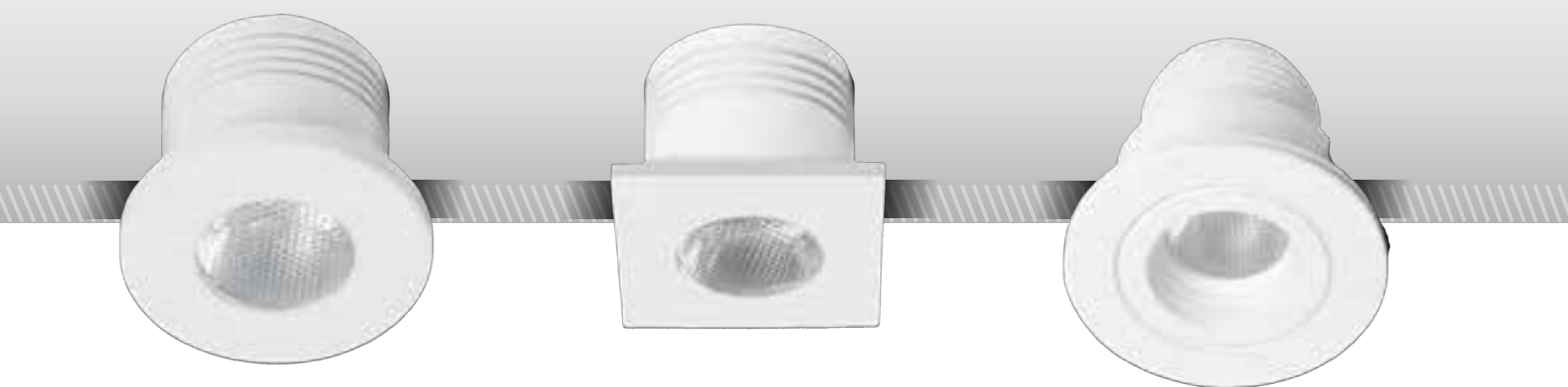





DOTFIX | MICRO | LED COB 3W | 110-240V ~50-60Hz



REF pcs  
81536 1pcs  
50618 1-3 pcs



REF pcs  
50607 1-3pcs

AL

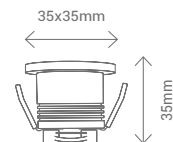

| REF    | CCT   | LM    | COLOR  |
|--------|-------|-------|--------|
| 100951 | 3000k | 170lm | blanco |

DOTFIX | MICRO | LED COB 3W | 110-240V ~50-60Hz



REF pcs  
81536 1pcs  
50618 1-3 pcs



REF pcs  
50607 1-3pcs

AL

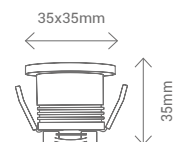

| REF    | CCT   | LM    | COLOR  |
|--------|-------|-------|--------|
| 100950 | 3000k | 170lm | blanco |

DOTFIX | MINI | LED COB 3W | 110-240V ~50-60Hz



AL

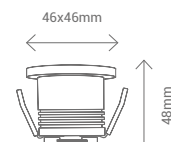

| REF    | CCT   | LM    | COLOR  |
|--------|-------|-------|--------|
| 100952 | 3000k | 170lm | blanco |
| 100953 | 4500K | 170lm | blanco |

DOTFIX | MINI | LED COB 3W | 110-240V ~50-60Hz



AL

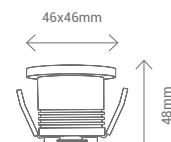

| REF    | CCT   | LM    | COLOR  |
|--------|-------|-------|--------|
| 100954 | 3000k | 170lm | blanco |
| 100955 | 4500K | 170lm | blanco |

DOTFIX | MINI | LED COB 5W | 110-240V ~50-60Hz



AL

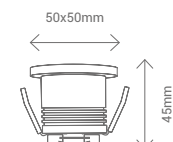

| REF    | CCT   | LM    | COLOR  |
|--------|-------|-------|--------|
| 112288 | 2700k | 400lm | blanco |

DOTFIX | MINI | LED COB 5W | 110-240V ~50-60Hz



AL

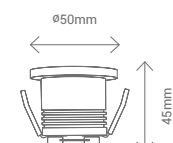

| REF    | CCT   | LM    | COLOR  |
|--------|-------|-------|--------|
| 112286 | 2700k | 400lm | blanco |

# D U C K



DUCK | EMPOTRABLE | LED COB 7W | 180-240V ~50-60Hz

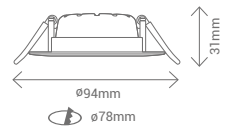

AL



| REF    | CCT   | LM    | COLOR  |
|--------|-------|-------|--------|
| 101254 | 3000K | 550lm | blanco |
| 101250 | 4000K | 570lm | blanco |

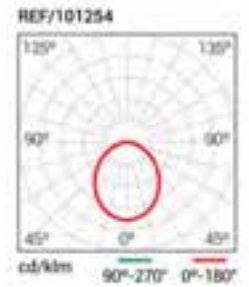

# ARUMFIX





ARUMFIX | MODULO | LED COB 9W | 100-240V~50-60Hz



AL

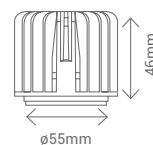

| REF    | CCT   | LM    | COLOR |
|--------|-------|-------|-------|
| 111077 | 3000K | 500lm | Negro |

ARUMFIX | MODULO | LED COB 9W | 100-240V~50-60Hz



AL

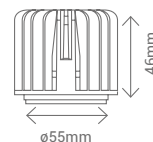

| REF    | CCT   | LM    | COLOR |
|--------|-------|-------|-------|
| 111078 | 3000K | 500lm | Negro |



ARUMFIX | REFLECTOR |



AL

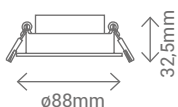

| REF    | COLOR  |
|--------|--------|
| 111031 | blanco |



AL

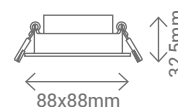

| REF    | COLOR  |
|--------|--------|
| 111032 | blanco |

# VISIO

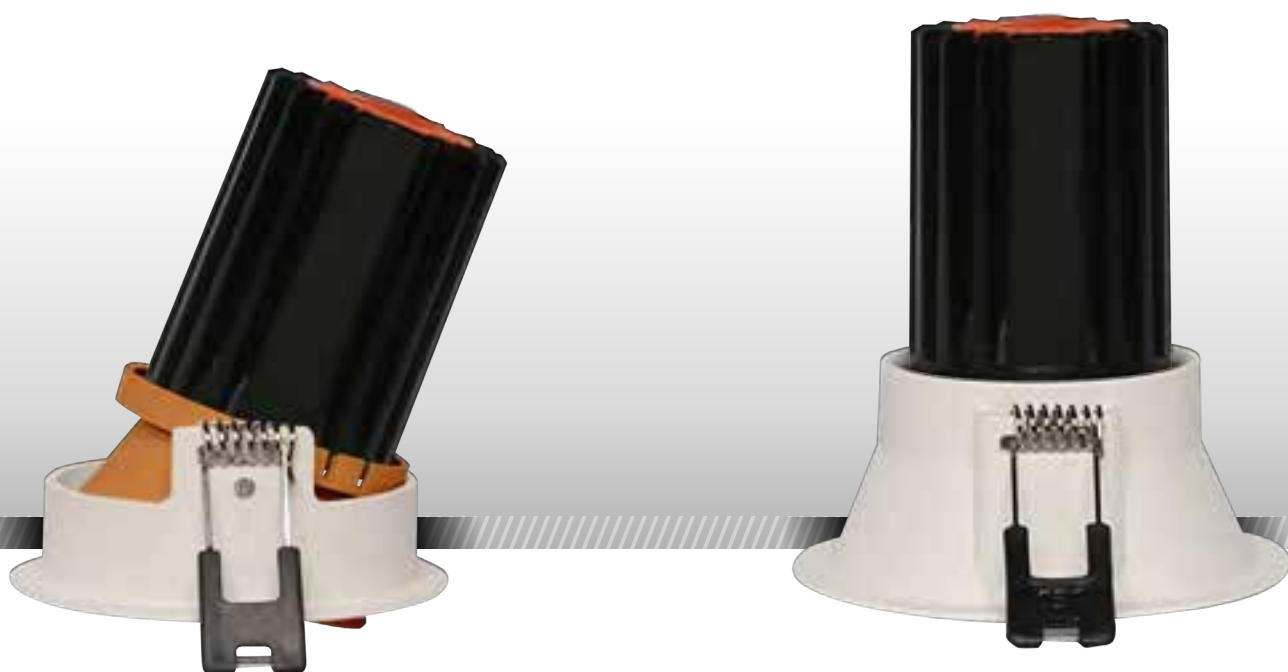



VISIO | MODULO | LED SMD 11W | 100-240V ~50-60Hz



**DRIVER**  
REF  
25153 12W  
25152 12W IoT



AL

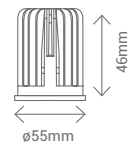

| REF    | Beam | CCT | LM    | COLOR |
|--------|------|-----|-------|-------|
| 101631 | 60°  | CCT | 950lm | Negro |
| 101630 | 24°  | CCT | 950lm | Negro |
| 101602 | 120° | CCT | 950lm | Negro |

BOMBILLA | GU10 | LED COB 5W |



AL



| REF   | CCT   | LM    | COLOR |
|-------|-------|-------|-------|
| 21299 | 4000K | 200lm | plata |

PORTALÁMPARA | GU10 | 220-240V ~50-60Hz



CR



| REF   | Beam | Lmm  |
|-------|------|------|
| 21400 | GU10 | 25cm |

PORTALÁMPARA | GU10 |



CR



| REF   | Beam | Lmm  |
|-------|------|------|
| 21300 | GU10 | 10cm |

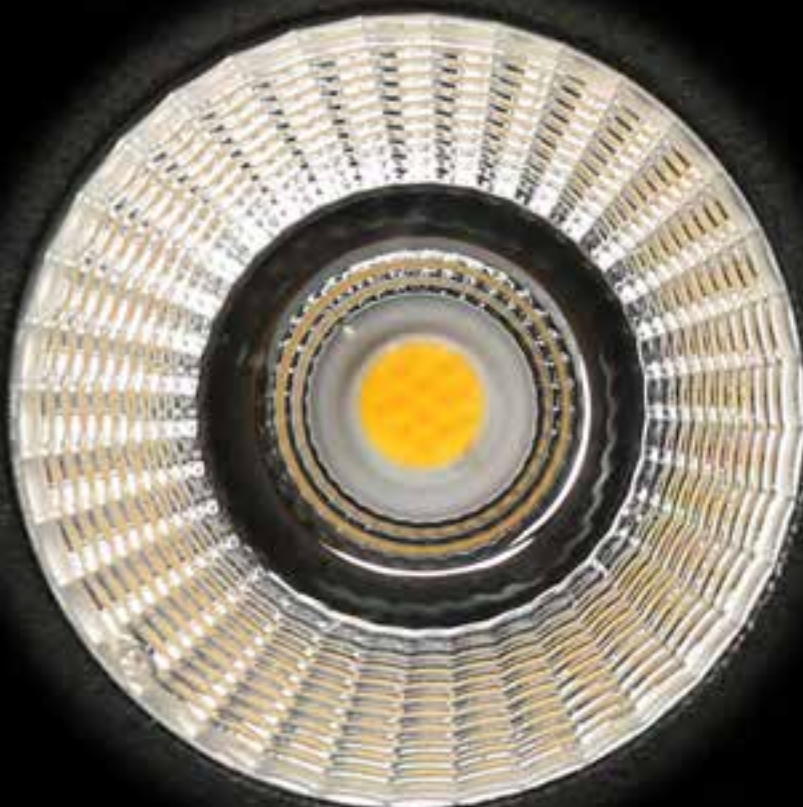

VISIO | REFLECTOR |



AL

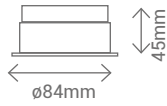

| REF    | COLOR  |
|--------|--------|
| 101621 | blanco |



AL

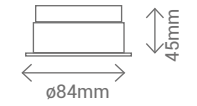

| REF    | COLOR           |
|--------|-----------------|
| 101628 | dorado + blanco |



AL

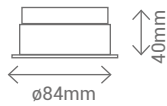

| REF    | COLOR  |
|--------|--------|
| 101618 | blanco |



AL

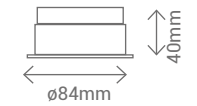

| REF    | COLOR           |
|--------|-----------------|
| 101627 | dorado + blanco |



AL

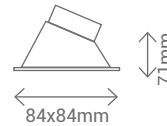

| REF    | COLOR  |
|--------|--------|
| 101624 | blanco |



AL

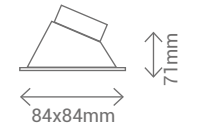

| REF    | COLOR  |
|--------|--------|
| 101629 | dorado |



AL

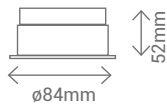

| REF    | COLOR  |
|--------|--------|
| 101606 | blanco |



AL

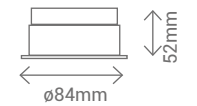

| REF    | COLOR           |
|--------|-----------------|
| 101614 | dorado + blanco |

VISIO | OPTICA



24°

| REF    | COLOR |
|--------|-------|
| 101604 | plata |



60°

| REF    | COLOR |
|--------|-------|
| 101605 | plata |

DRIVER



MÓDULO



ÓPTICA



REFLECTORES



SAND



VISIO



ARC

A R C

S A N D





ARC | REFLECTOR |



AL

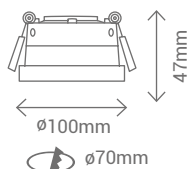

| REF    | COLOR  |
|--------|--------|
| 112364 | blanco |



AL

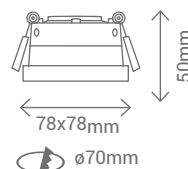

| REF    | COLOR  |
|--------|--------|
| 112368 | blanco |



SAND | ARO |



M

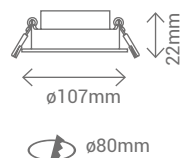

| REF    | COLOR  |
|--------|--------|
| 101178 | blanco |



M

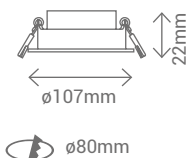

| REF    | COLOR  |
|--------|--------|
| 101179 | níquel |



AL

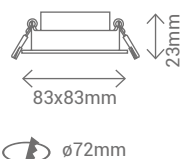

| REF    | COLOR  |
|--------|--------|
| 101180 | blanco |

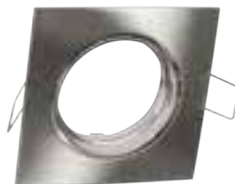

AL

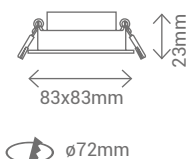

| REF    | COLOR  |
|--------|--------|
| 101181 | níquel |



# TURK



TURK | EMPOTRABLE | LED SMD 20W | 100-265V ~50-60Hz

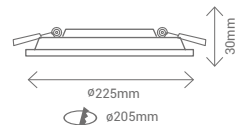

AL



| REF    | CCT   | LM     | COLOR  |
|--------|-------|--------|--------|
| 101266 | 3000K | 2150lm | blanco |
| 101265 | 4000K | 2200lm | blanco |

TURK | EMPOTRABLE | LED SMD 20W | 100-265V ~50-60Hz

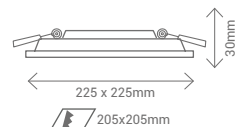

AL



| REF    | CCT   | LM     | COLOR  |
|--------|-------|--------|--------|
| 102266 | 3000K | 2150lm | blanco |
| 102265 | 4000K | 2200lm | blanco |



1-10V REGULATION

TRIAC REGULATION

MONTAJE TRIAC / MOUNTING TRIAC / MONTAGE TRIAC / MONTAGEM TRIAC

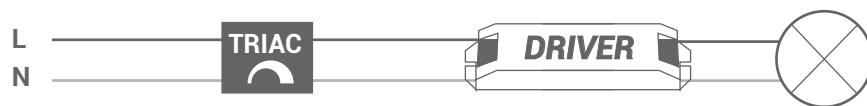

MONTAJE 1-10V / MOUNTING 1-10V / MONTAGE 1-10V / MONTAGEM 1-10V

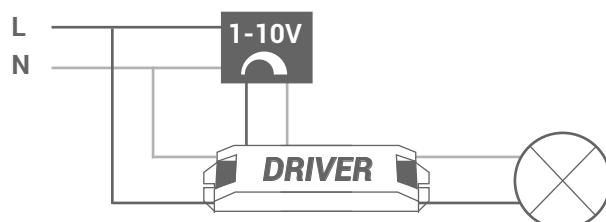

# THOR



THOR | EMPOTRABLE | LED COB 20W | 220-240V ~50-60Hz

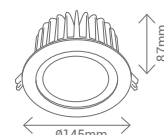

AL + G



| REF    | CCT   | LM     | COLOR  |
|--------|-------|--------|--------|
| 101753 | 3000K | 1800lm | blanco |
| 101759 | 4000K | 1850lm | blanco |

THOR | EMPOTRABLE | LED COB 40W | 220-240V ~50-60Hz

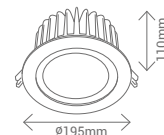

AL + G



| REF    | CCT   | LM     | COLOR  |
|--------|-------|--------|--------|
| 100760 | 3000K | 3500lm | blanco |
| 100752 | 4000K | 3650lm | blanco |

THOR | EMPOTRABLE | LED COB 60W | 220-240V ~50-60Hz

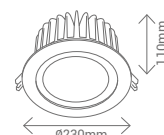

AL + G



| REF    | CCT   | LM     | COLOR  |
|--------|-------|--------|--------|
| 100759 | 3000K | 5400lm | blanco |
| 100753 | 4000K | 5450lm | blanco |

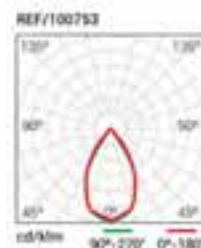

# BUGY



**BUGY | EMPOTRABLE | LED SMD 15W | 220-240V ~50-60Hz**



\*Driver integrado / Integrated / Intégré / integrado

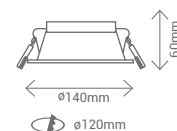

| REF    | CCT   | LM     | COLOR  |
|--------|-------|--------|--------|
| 101175 | 3000K | 1200lm | blanco |
| 101176 | 4000K | 1250lm | blanco |

**BUGY | EMPOTRABLE | LED SMD 20W | 220-240V ~50-60Hz**



\*Driver integrado / Integrated / Intégré / integrado

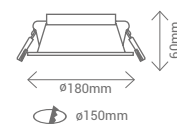

| REF    | CCT   | LM     | COLOR  |
|--------|-------|--------|--------|
| 101173 | 3000K | 1600lm | blanco |
| 101174 | 4000K | 1650lm | blanco |

**BUGY | EMPOTRABLE | LED SMD 25W | 220-240V ~50-60Hz**



\*Driver integrado / Integrated / Intégré / integrado

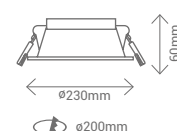

| REF    | CCT   | LM     | COLOR  |
|--------|-------|--------|--------|
| 101172 | 3000K | 2100lm | blanco |
| 101149 | 4000K | 2150lm | blanco |

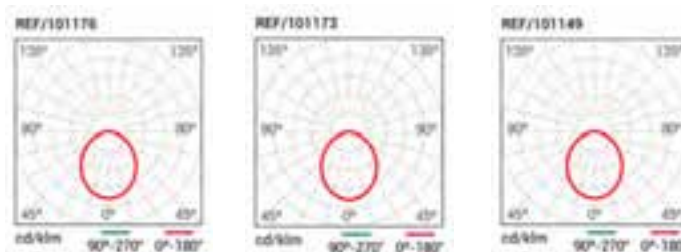

# THIN



**THIN | PROYECTOR | SMD 3W | 100-240V~50-60Hz**



AL + G

35.000h  $\text{U}_{20\sim+40^\circ\text{C}}$  PF 0.50  $\text{IP 20}$  13°  $\text{A+}$  CRI >80

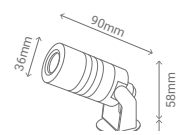

| REF    | CCT   | LM  | COLOR |
|--------|-------|-----|-------|
| 111250 | 3000K | 130 | negro |

**THIN | PROYECTOR | COB 10W | 220-240V~50-60Hz**



AL + G

35.000h  $\text{U}_{20\sim+40^\circ\text{C}}$  PF 0.50  $\text{IP 20}$  13°  $\text{A+}$  CRI >80

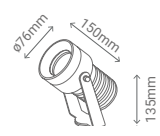

| REF    | CCT   | LM  | COLOR |
|--------|-------|-----|-------|
| 111251 | 3000K | 910 | negro |



# PEG



PEG | PROYECTOR | COB 6W | 200-240V~50-60Hz

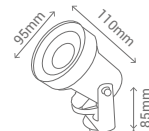

| AL + G | 40.000 h | -5~+40°C | ψ PF 0.50 | IP 20 | 25° | A+ | CR1 85 |
|--------|----------|----------|-----------|-------|-----|----|--------|
| REF    | CCT      | LM       | COLOR     |       |     |    |        |
| 112205 | 3000K    | 550      | negro     |       |     |    |        |

P E N N



PENN | WALL WASHER | LED SMD 18W | 24V DC 50-60Hz



| REF                           | pcs | REF                           | pcs |
|-------------------------------|-----|-------------------------------|-----|
| 24125 / 24020 / 24730 / 24630 | 1   | 24010 / 24100 / 24710 / 24680 | 5   |
| 24135 / 24035 / 24740 / 24640 | 1   | 24150 / 24350 / 24715 / 24615 | 8   |
| 24060                         | 3   | 24200 / 24720 / 24620         | 11* |
| 24175 / 24780 / 24680         | 3   | 24250 / 24725 / 24625         | 13* |



AL + G

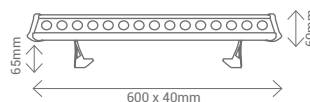

| REF    | CCT   | LM     | COLOR           |
|--------|-------|--------|-----------------|
| 103795 | 2700K | 1150lm | aluminio/ negro |
| 103796 | 4000K | 1350lm | aluminio/ negro |

PENN | WALL WASHER | LED SMD 18W | 24V DC 50-60Hz



| REF                           | pcs | REF                           | pcs |
|-------------------------------|-----|-------------------------------|-----|
| 24125 / 24020 / 24730 / 24630 | 1   | 24010 / 24100 / 24710 / 24680 | 5   |
| 24135 / 24035 / 24740 / 24640 | 1   | 24150 / 24350 / 24715 / 24615 | 8   |
| 24060                         | 3   | 24200 / 24720 / 24620         | 11* |
| 24175 / 24780 / 24680         | 3   | 24250 / 24725 / 24625         | 13* |



AL + G

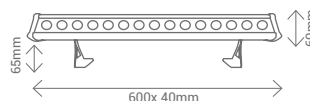

| REF    | CCT | LM | COLOR           |
|--------|-----|----|-----------------|
| 104795 | RGB | -  | aluminio/ negro |

PENN | WALL WASHER | LED SMD 36W | 24V DC 50-60Hz



| REF                           | pcs | REF                           | pcs |
|-------------------------------|-----|-------------------------------|-----|
| 24740 / 24640                 | 1   | 24150 / 24350 / 24715 / 24615 | 4   |
| 24060                         | 1   | 24200 / 24720 / 24620         | 5   |
| 24175 / 24780 / 24680         | 2   | 24250 / 24725 / 24625         | 6   |
| 24010 / 24100 / 24710 / 24610 | 2   |                               |     |



AL + G

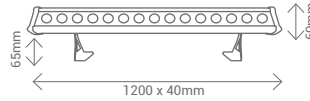

| REF    | CCT   | LM     | COLOR           |
|--------|-------|--------|-----------------|
| 103798 | 2700K | 2250lm | aluminio/ negro |
| 103799 | 4000K | 2750lm | aluminio/ negro |

PENN | WALL WASHER | LED SMD 36W | 24V DC 50-60Hz



| REF                           | pcs | REF                           | pcs |
|-------------------------------|-----|-------------------------------|-----|
| 24740 / 24640                 | 1   | 24150 / 24350 / 24715 / 24615 | 4   |
| 24060                         | 1   | 24200 / 24720 / 24620         | 5   |
| 24175 / 24780 / 24680         | 2   | 24250 / 24725 / 24625         | 6   |
| 24010 / 24100 / 24710 / 24610 | 2   |                               |     |



AL + G

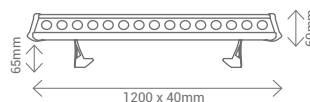

| REF    | CCT | LM | COLOR           |
|--------|-----|----|-----------------|
| 103797 | RGB | -  | aluminio/ negro |

\*Necesario amplificador

**PENN | ANTIREFLECTOR |**



|   | REF | Lmm  |
|---|-----|------|
| ⬆ | 🛒   | 600  |
| ⬆ | 🛒   | 1200 |

🛒 articulo bajo pedido previo

**PENN | CONECTOR ♀ | IP66 0.5m**



|   | REF   | sec. Ø              | Lmm |
|---|-------|---------------------|-----|
| ⬆ | 10080 | 0,75mm <sup>2</sup> | 500 |

**PENN | TAPON ♀ |**



|   | REF   | sec. Ø | Lmm |
|---|-------|--------|-----|
| ⬆ | 10081 | -      | -   |

**PENN | TAPON | 65mm**



|   | REF   | sec. Ø | Lmm |
|---|-------|--------|-----|
| ⬆ | 10083 | -      | 65  |

**PENN | FIJACIÓN | 37mm**



|   | REF   | sec. Ø | Lmm |
|---|-------|--------|-----|
| ⬆ | 10084 | -      | 37  |

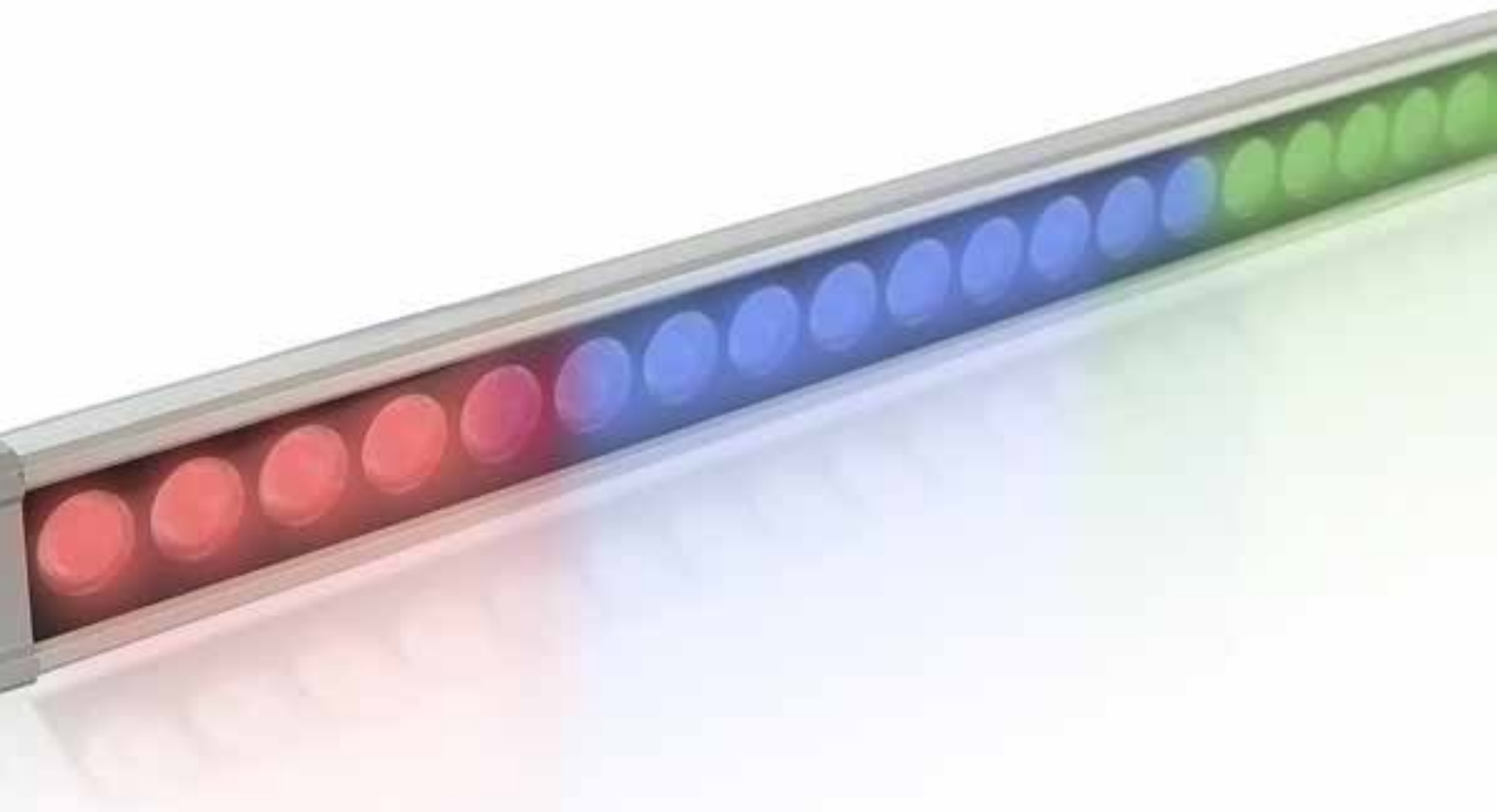



# TRIME



TRIME | PANTALLA | LED SMD 30W | 220-240V ~50-60Hz



REF 10901 incl.



| REF    | CCT         | LM     | COLOR          |
|--------|-------------|--------|----------------|
| 112011 | 3000K-6000K | 2700lm | plata + blanco |

TRIME | PANTALLA | LED SMD 40W | 220-240V ~50-60Hz



REF 10901 incl.



| REF    | CCT         | LM     | COLOR          |
|--------|-------------|--------|----------------|
| 112012 | 3000K-6000K | 3700lm | plata + blanco |

TRIME | PANTALLA | LED SMD 60W | 220-240V ~50-60Hz



REF 10901 incl.



| REF    | CCT         | LM     | COLOR          |
|--------|-------------|--------|----------------|
| 112013 | 3000K-6000K | 5400lm | plata + blanco |





B E C O O L

B E L O W





**BELOW | UNDERCABINET | LED SMD 25W | 220-240V~50-60Hz**

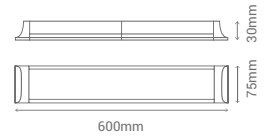

AL + PC



| REF    | CCT   | LM     | COLOR  |
|--------|-------|--------|--------|
| 102011 | 4000k | 2175lm | blanco |

**BELOW | UNDERCABINET | LED SMD 45W | 220-240V~50-60Hz**

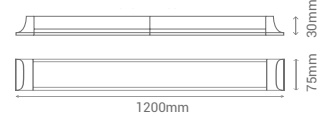

AL + PC



| REF    | CCT   | LM     | COLOR  |
|--------|-------|--------|--------|
| 102041 | 4000k | 3800lm | blanco |

**BECOOL | UNDERCABINET | LED SMD 18W | 220-240V~50-60Hz**

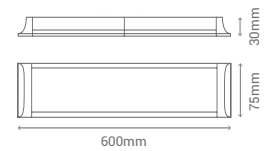

PVC



| REF    | CCT   | LM     | COLOR  |
|--------|-------|--------|--------|
| 102025 | 4000k | 1700lm | blanco |

**BECOOL | UNDERCABINET | LED SMD 40W | 220-240V~50-60Hz**

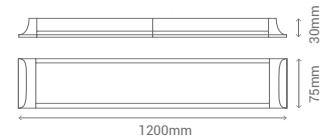

PVC



| REF    | CCT   | LM     | COLOR  |
|--------|-------|--------|--------|
| 102027 | 4000k | 3500lm | blanco |



# KITCH

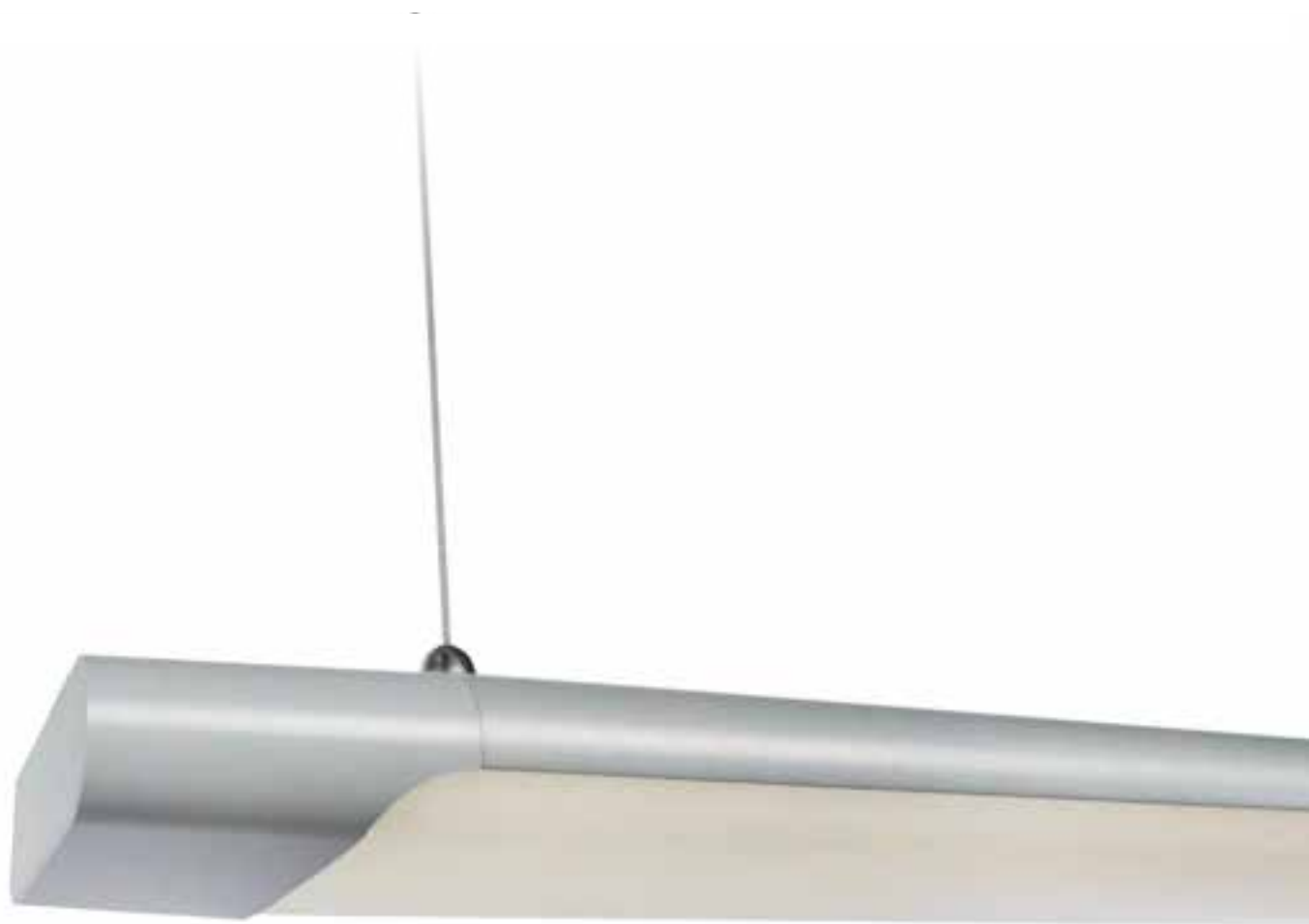

KITCH | PANTALLA | LED SMD 30W | 200-240V ~50-60Hz



| REF    | CCT   | LM     | COLOR          |
|--------|-------|--------|----------------|
| 112300 | 4000K | 2600lm | plata + blanco |

KITCH | PANTALLA | LED SMD 40W | 200-240V ~50-60Hz

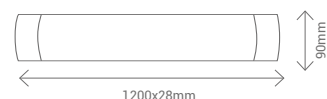

| REF    | CCT   | LM     | COLOR          |
|--------|-------|--------|----------------|
| 112305 | 4000K | 3450lm | plata + blanco |



# ALPHA



ALPHA | PLAFON | LED COB 7W | 90-240V~50-60Hz



AL

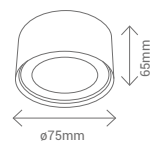

| REF    | CCT   | LM    | COLOR  |
|--------|-------|-------|--------|
| 100818 | 4000K | 600lm | blanco |

ALPHA | PLAFON | LED COB 7W | 90-240V~50-60Hz



AL

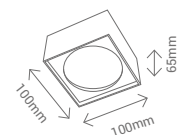

| REF    | CCT   | LM    | COLOR  |
|--------|-------|-------|--------|
| 100819 | 4000K | 600lm | blanco |



A S T O N      R A Y F I X      L I N D E F I X



**ASTON | WALL WASHER | LED COB 3,5W | 220-240V ~50-60Hz**



AL

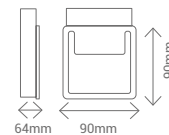

| REF    | CCT   | LM    | COLOR  |
|--------|-------|-------|--------|
| 111090 | 3000K | 160lm | blanco |

**RAYFIX | WALLWASHER | LED COB 3W | 110-240V ~50-60Hz**



AL

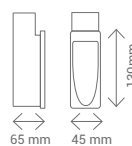

| REF    | CCT   | LM    | COLOR  |
|--------|-------|-------|--------|
| 111042 | 3000K | 160lm | blanco |

**LINDEFIX | WALLWASHER | LED COB 3W | 110-240V ~50-60Hz**



AL

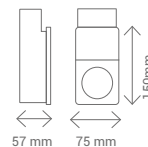

| REF    | CCT   | LM    | COLOR  |
|--------|-------|-------|--------|
| 111041 | 3000K | 100lm | blanco |



# COLOSSAL





COLOSSAL | PLAFON | LED SMD 45W | 100-240V ~50-60Hz



REF 102193



AL + AC



| REF    | CCT         | LM     | COLOR  |
|--------|-------------|--------|--------|
| 101190 | 2800K-5500K | 4200lm | blanco |

COLOSSAL | PLAFON | LED SMD 45W | 100-240V ~50-60Hz



REF 102193



AL + AC



| REF    | CCT         | LM     | COLOR  |
|--------|-------------|--------|--------|
| 101191 | 2800K-5500K | 4200lm | blanco |

COLOSSAL | PLAFON | LED SMD 45W | 100-240V ~50-60Hz



REF 102193



AL + AC



| REF    | CCT         | LM     | COLOR  |
|--------|-------------|--------|--------|
| 101192 | 2800K-5500K | 4200lm | blanco |





**C O L O S S A L**



**D W 3 6 0**



**T R I M E**

# CICLO CIRCADIANO

Circadian cycle  
Cycle circadien  
Ciclo circadiano



## ACTÍVATE



Get going  
Activez-vous  
Ative

## RELÁJATE



Relax  
Détendez-vous  
Relaxe



### Se adapta a tus ritmos circadianos

Adapts to your circadian cycle  
S'adapte à tes rythmes circadiens  
Adapta-se aos ritmos circadianos

Los ritmos circadianos son cambios físicos, mentales y conductuales que experimenta nuestro cuerpo durante las 24h del día en función de la temperatura de color que ofrece la luz natural. Circadian rhythms are physical, mental and behavioural changes in our body caused by the changes in colour temperature of natural light during the day.

Les rythmes circadiens sont les changements physiques, mentaux et comportementaux expérimentés par notre corps durant la journée et causés par la température de couleur de la lumière naturelle.

Os ritmos circadianos são mudanças físicas, mentais e comportamentais que o nosso corpo experimenta durante 24h por dia, dependendo da temperatura de cor oferecida pela luz natural.



### Es regulable

Adjustable  
Ajustable  
Regulável

Se puede regular la temperatura de color y la intensidad de la luz. Colour temperature and light intensity are adjustable. La température de couleur et l'intensité de la lumière sont ajustables. Pode regular a temperatura da cor e a intensidade da luz.



### Controlas la luz con un mando

Light is controlled with a remote  
Une télécommande contrôle la lumière  
Controlas a luz com um comando

Incluye un mando a distancia que permite regular tanto la temperatura de color, de cálido a frío, y regular la intensidad de la luz en todo su rango. Permite usar un sólo mando para varias unidades, en caso que sea necesario, aunque en cada pieza viene incluido un control remoto.

A remote control is included, to adjust not only the colour temperature, from cold to warm, but also light intensity. A unique remote can be used for several units, even if each luminaire comes with a remote

Comprend une télécommande qui permet le réglage de la température de couleur, de froid a chaud, et de l'intensité de la lumière. Une unique télécommande peut contrôler plusieurs unités, bien que chaque luminaire inclus une télécommande.

Inclui um comando que permite regular a temperatura de cor, de quente a frio, e regular a intensidade da luz ao longo do seu ciclo. Permite usar um único comando para várias unidades, caso seja necessário, mesmo que em cada painel venha incluido um controle remoto.



### Se puede programar el encendido y apagado de la unidad

On & Off can be programmed  
La mise en marche et l'arrêt peuvent être programmés  
Pode ser programado o ligar e desligar da unidade.

**Sin usar el mando, la pieza enciende directamente al pulsar el interruptor de pared.**

Without remote, the luminaire can be turned off with the wall switch

Sans télécommande, le luminaire peut s'éteindre avec l'interrupteur.

Sem usar o comando, o painel acende-se directamente quando o interruptor da parede é pressionado.

# C I F O



CIFO | PLAFON | LED SMD 20W | 220-240V ~50-60Hz



AL



| REF    | CCT   | LM     | COLOR  |
|--------|-------|--------|--------|
| 111770 | 4000K | 1500lm | blanco |

CIFO | PLAFON | LED SMD 20W | 220-240V ~50-60Hz

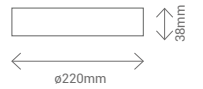

AL



| REF    | CCT   | LM     | COLOR  |
|--------|-------|--------|--------|
| 100770 | 4000K | 1500lm | blanco |



# T A P E

TAPE | PANEL | LED SMD 45W | 90-265V ~50-60Hz



| REF    | CCT   | LM     | COLOR  |
|--------|-------|--------|--------|
| 112168 | 4000K | 5400lm | blanco |
| 112968 | 5000K | 5600lm | blanco |



Disipador de aluminio  
Aluminio heat sink  
Dissipateur d'aluminium  
Dissipador de alumínio











# PLATE



PLATE | PANEL | LED SMD 40W | 85-265V ~50-60Hz

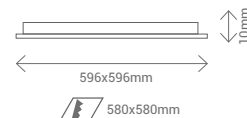

AL



| REF    | CCT   | LM     | COLOR  |
|--------|-------|--------|--------|
| 112361 | 4000K | 3200lm | blanco |
| 112367 | 5500K | 3280lm | blanco |

PLATE | PANEL | LED SMD 40W | 85-265V ~50-60Hz



AL



| REF    | CCT   | LM     | COLOR  |
|--------|-------|--------|--------|
| 100846 | 4000K | 3200lm | blanco |



REF 81570

PLATE | PANEL | LED SMD 40W | 85-265V ~50-60Hz

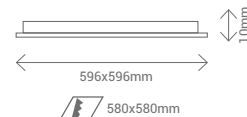

AL



| REF    | CCT         | LM     | COLOR  |
|--------|-------------|--------|--------|
| 113150 | 3000K-6000K | 3200lm | blanco |



REF 80621  
80536

PLATE | PANEL | LED SMD 36W | 100-240V ~50-60Hz



AL



| REF    | CCT | LM | COLOR  |
|--------|-----|----|--------|
| 101056 | RGB | -  | blanco |



| REF                   | pcs | REF                           | pcs |
|-----------------------|-----|-------------------------------|-----|
| 24740 / 24640         | 1   | 24150 / 24350 / 24715 / 24615 | 4   |
| 24060                 | 1   | 24200 / 24720 / 24620         | 5   |
| 24175 / 24780 / 24680 | 2   | 24250 / 24725 / 24625         | 6   |
| REF 80625 incl.       | 2   | 24010 / 24100 / 24710 / 24610 | 2   |

PLATE | KIT DE SUSPENSIÓN |



| REF   | Lmm    | Color    |
|-------|--------|----------|
| 50615 | 1000mm | aluminio |

PLATE | MARCO | 60x60mm



| REF   | Lmm          | Color  |
|-------|--------------|--------|
| 50623 | 600x600x40mm | blanco |

D W 3 6 0



DW360 | PANEL | LED SMD 24W | 220-240V ~50-60Hz



REF 10133

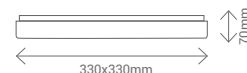

AC + AL



| REF    | CCT         | LM     | COLOR  |
|--------|-------------|--------|--------|
| 101212 | 2800K-5500K | 1500lm | blanco |

DW360 | PANEL | LED SMD 36W | 220-240V ~50-60Hz



REF 10133



AC + AL



| REF    | CCT         | LM     | COLOR  |
|--------|-------------|--------|--------|
| 101211 | 2800K-5500K | 2300lm | blanco |

DW360 | PANEL | LED SMD 48W | 220-240V ~50-60Hz



REF 10133

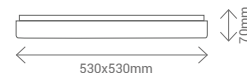

AC + AL



| REF    | CCT         | LM     | COLOR  |
|--------|-------------|--------|--------|
| 101210 | 2800K-5500K | 3100lm | blanco |

DW360 | PANEL | LED SMD 48W | 220-240V ~50-60Hz



REF 10133

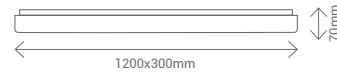

AC + AL



| REF    | CCT         | LM     | COLOR  |
|--------|-------------|--------|--------|
| 101213 | 2800K-5500K | 3100lm | blanco |

DW360 | PANEL | LED SMD 48W | 220-240V ~50-60Hz



REF 10133



AC + AL



| REF    | CCT         | LM     | COLOR  |
|--------|-------------|--------|--------|
| 101214 | 2800K-5500K | 3100lm | blanco |





# PEAK





PEAK | PANEL | LED SMD 34W | 220-240V ~50-60Hz



1-10V INCL

AL

35.000 h  $\Psi$  0.95 IP 20 150° A++ CRI 80

| REF    | CCT   | LM     | COLOR  |
|--------|-------|--------|--------|
| 100832 | 4000K | 3300lm | blanco |

PEAK | PANEL | LED SMD 36W | 220-240V ~50-60Hz



1-10V INCL

AL

35.000 h  $\Psi$  0.95 IP 20 150° A++ CRI 80

| REF    | CCT   | LM     | COLOR  |
|--------|-------|--------|--------|
| 100834 | 4000K | 4190lm | blanco |

PEAK | PANEL | LED SMD 34W | 220-240V ~50-60Hz



1-10V INCL

AL

35.000 h  $\Psi$  0.95 IP 20 150° A++ CRI 80

| REF    | CCT   | LM     | COLOR  |
|--------|-------|--------|--------|
| 100836 | 4000K | 3300lm | blanco |

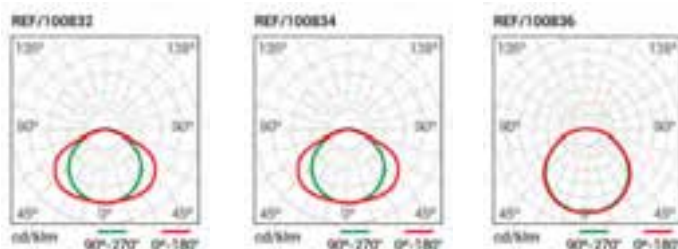

PEAK | MARCO | 600x600mm



| REF   | Lmm          | Color  |
|-------|--------------|--------|
| 50627 | 600x600x40mm | blanco |

PEAK | MARCO | 1200x300 mm



| REF   | Lmm           | Color  |
|-------|---------------|--------|
| 50628 | 1200x300x40mm | blanco |

PEAK | KIT EMERGENCIA | 1h



| REF   | Lmm | Color  |
|-------|-----|--------|
| 50629 | -   | blanco |



# K O R U



**KORU | TUBO G13 | LED SMD 9W | 220-240V ~50-60Hz**

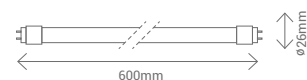

**G** + **A**

| REF    | CCT   | LM    | COLOR  |
|--------|-------|-------|--------|
| 101400 | 4000K | 850lm | blanco |
| 101401 | 6500K | 900lm | blanco |

**KORU | TUBO G13 | LED SMD 15W | 220-240V ~50-60Hz**

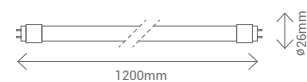

**G** + **A**

| REF    | CCT   | LM     | COLOR  |
|--------|-------|--------|--------|
| 101402 | 4000K | 1750lm | blanco |
| 101403 | 6500K | 1800lm | blanco |

**KORU | TUBO G13 | LED SMD 24W | 220-240V ~50-60Hz**

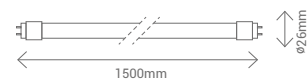

**G** + **A**

| REF    | CCT   | LM     | COLOR  |
|--------|-------|--------|--------|
| 101404 | 4000K | 2350lm | blanco |
| 101405 | 6500K | 2400lm | blanco |

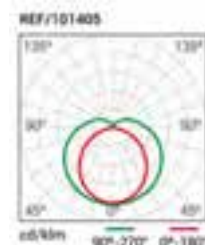

MONTAJE A / MOUNTING A / MONTAGE A / MONTAGEM A

MONTAJE 1x / MOUNTING 1x / MONTAGE 1x / MONTAGEM 1x

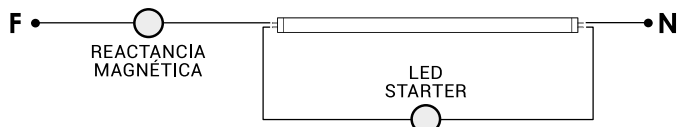

MONTAJE 2x / MOUNTING 2x / MONTAGE 2x / MONTAGEM 2x

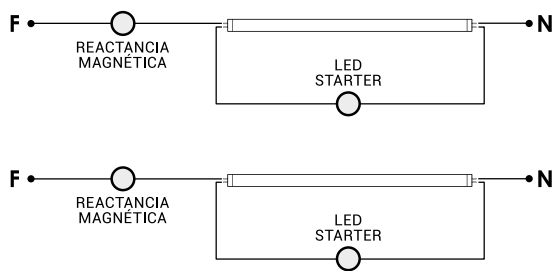

MONTAJE NO DISPONIBLE / MOUNTING NOT AVAILABLE / MONTAGE NON DISPONIBLE / MONTAGEM NÃO DISPONÍVEL

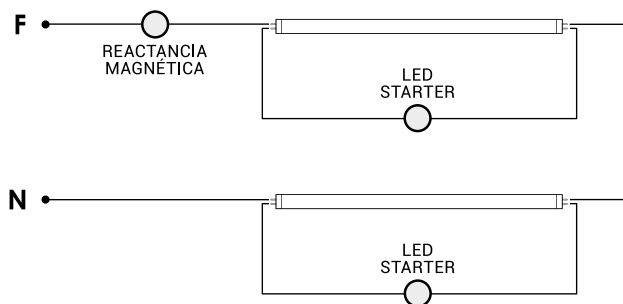

MONTAJE B / MOUNTING B / MONTAGE B / MONTAGEM B

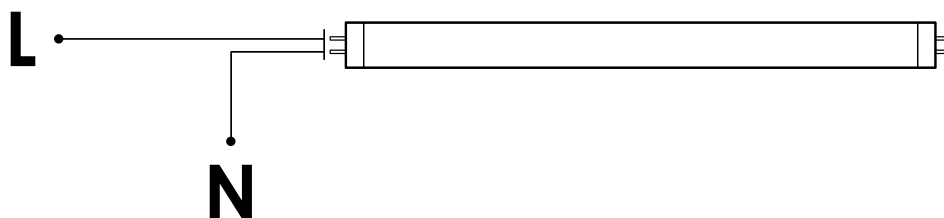

EXTREMO DE ALIMENTACIÓN / POWER END / EXTRÉMITÉ D'ALIMENTATION / EXTREMO DE ALIMENTAÇÃO

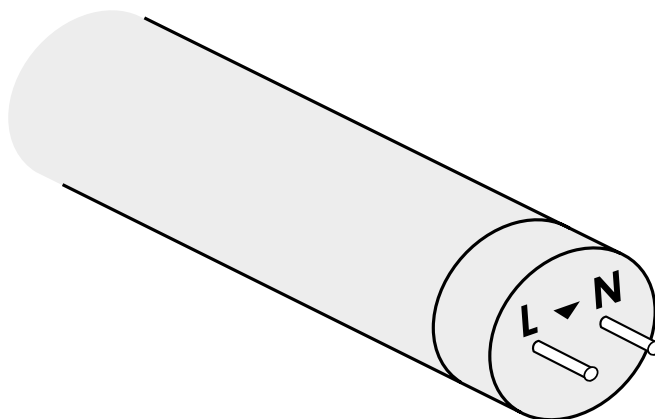

TUBO FLUORESCENTE  
FLUORESCENT TUBE  
TUBE FLUORESCENT  
TUBO FLUORESCENTE

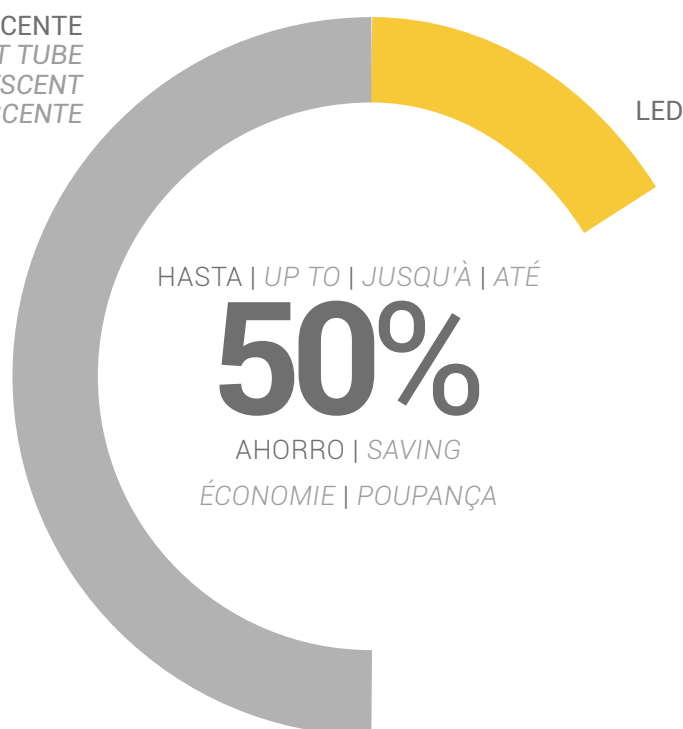

LED

| TUBO FLUORESCENTE<br>FLUORESCENT TUBE<br>TUBE FLUORESCENT<br>TUBO FLUORESCENTE  |
|---|
| 18W   |
| 36W   |
| 58W   |
| Contiene <b>mercurio</b> perjudicial para la salud<br>Contains <b>mercury</b> , harmful for your health<br>Contiens du <b>mercure</b> dangereux pour la santé<br>Contém <b>mercúrio</b> prejudicial à saúde                   |
| 8.000 horas de vida útil<br>8.000 hours of lifetime<br>8.000 heures de vie utile<br>8.000 horas de vida útil  |
| Encendido <b>gradual</b><br>Gradual ignition<br>Mise en route <b>graduelle</b><br>Ignição <b>progressiva</b>  |
| Vida útil <b>degradada</b> por los encendidos<br>Shelf-life <b>reduced by</b> de ignitions<br>Vie utile <b>réduite</b> par les mises en route<br>Vida útil <b>degradada</b> pelas cognições                                   |
| <b>Sensible</b> a vibraciones<br>Affected by vibrations<br><b>Sensible</b> aux vibrations<br><b>Sensível</b> às vibrações   |
| Luz omnidireccional, requiere <b>recuperador</b><br>Omnidirectional light, requires <b>flow recuperator</b><br>Lumière omnidirectionnelle, nécessite un <b>récupérateur</b><br>Luz omnidireccional, requer <b>recuperador</b> |



| LED   |
|---|
| 9W  |
| 18W   |
| 24W   |
| No contiene mercurio<br>Doesn't contain mercury<br>No contient pas de mercure<br>Não contém mercúrio  |
| 25.000 horas de vida útil<br>25.000 hours of lifetime<br>25.000 heures de vie utile<br>25.000 horas de vida útil  |
| Encendido <b>inmediato</b> libre de parpadeo<br>Immediate ignition without flickering<br>Mise en route <b>immédiate</b> sans clignotement<br>Inflamação <b>imediate</b> sem flash                           |
| Los encendidos <b>no</b> afectan a la vida útil<br>Ignitions <b>doesn't</b> reduce shelf-life<br>Les mises en route <b>ne</b> réduisent pas la vie utile<br>As ignições <b>não</b> afectam a vida útil.     |
| <b>Resistente</b> a vibraciones<br>Unaffected by vibrations<br><b>Résistant</b> aux vibrations<br><b>Resistente</b> a vibrações   |
| No requiere recuperadores, ni emite <b>FHS</b><br>Recuperators not required, doesn't emit <b>FHS</b><br>Récupérateurs superflus, n'émet pas de <b>FHS</b><br>Não requer recuperadores, nem emite <b>FHS</b> |

# T 5 LINE





**T5 LINE | UNDERCABINET | LED SMD 4W | 200-240V ~50-60Hz**

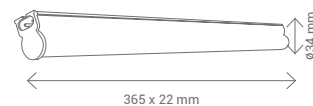

| PVC     |                             |             |          |
|---------|-----------------------------|-------------|----------|
| 25.000h | U <sub>E</sub> -5~<br>+40°C | Φ<br>PF0.90 | IP<br>20 |
|         |                             |             | 160°     |
|         |                             |             | A+       |
|         |                             |             | CRI 80   |
| REF     | CCT                         | LM          | COLOR    |
| 101032  | 4000K                       | 450lm       | blanco   |

**T5 LINE | UNDERCABINET | LED SMD 8W | 200-240V ~50-60Hz**

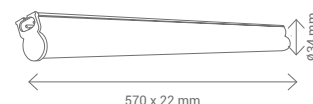

| PVC     |                             |             |          |
|---------|-----------------------------|-------------|----------|
| 25.000h | U <sub>E</sub> -5~<br>+40°C | Φ<br>PF0.90 | IP<br>20 |
|         |                             |             | 160°     |
|         |                             |             | A+       |
|         |                             |             | CRI 80   |
| REF     | CCT                         | LM          | COLOR    |
| 101026  | 4000K                       | 800lm       | blanco   |

**T5 LINE | UNDERCABINET | LED SMD 12W | 200-240V ~50-60Hz**

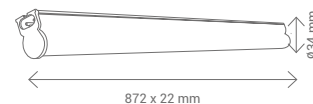

| PVC     |                             |             |          |
|---------|-----------------------------|-------------|----------|
| 25.000h | U <sub>E</sub> -5~<br>+40°C | Φ<br>PF0.90 | IP<br>20 |
|         |                             |             | 160°     |
|         |                             |             | A+       |
|         |                             |             | CRI 80   |
| REF     | CCT                         | LM          | COLOR    |
| 101034  | 4000K                       | 1300lm      | blanco   |

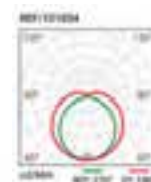

**T5 line | CONEXIÓN UNION | 150mm**



| REF   | Lmm | Color  |
|-------|-----|--------|
| 60612 | 150 | blanco |

**T5 line | CONEXIÓN SALIDA | 700mm**



| REF   | Lmm | Color  |
|-------|-----|--------|
| 60613 | 700 | blanco |

# HOLE

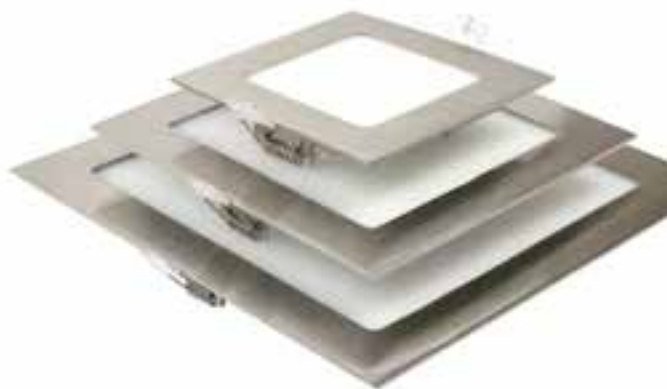

# SURF



HOLE | EMPOTRABLE | LED SMD 6W | 90-265V ~50-60Hz



AL + AC



| REF    | CCT   | LM    | COLOR  |
|--------|-------|-------|--------|
| 366113 | 2700K | 430lm | blanco |
| 366111 | 4000K | 450lm | blanco |
| 366115 | 5500K | 470lm | blanco |
| 366116 | 2700K | 430lm | níquel |
| 366112 | 4000K | 450lm | níquel |
| 366114 | 5500K | 470lm | níquel |

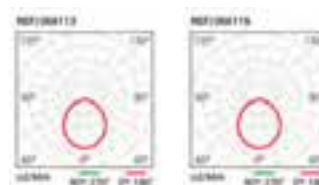

HOLE | EMPOTRABLE | LED SMD 12W | 90-265V ~50-60Hz

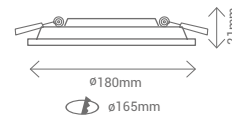

AL + AC



| REF    | CCT   | LM    | COLOR  |
|--------|-------|-------|--------|
| 366108 | 2700K | 865lm | blanco |
| 366106 | 4000K | 910lm | blanco |
| 366110 | 5500K | 955lm | blanco |
| 366109 | 2700K | 865lm | níquel |
| 366107 | 4000K | 910lm | níquel |
| 366117 | 5500K | 955lm | níquel |

HOLE | EMPOTRABLE | LED SMD 18W | 90-265V ~50-60Hz

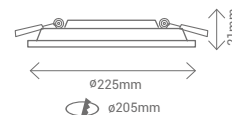

AL + AC



| REF    | CCT   | LM     | COLOR  |
|--------|-------|--------|--------|
| 365092 | 2700K | 1425lm | blanco |
| 365090 | 4000K | 1500lm | blanco |
| 365091 | 5500K | 1600lm | blanco |
| 100821 | 2700K | 1425lm | níquel |
| 100822 | 4000K | 1500lm | níquel |
| 100823 | 5500K | 1625lm | níquel |



**HOLE | EMPOTRABLE | LED SMD 6W | 90-265V ~50-60Hz**

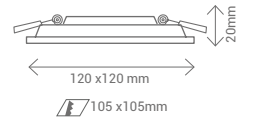

AL + AC



| REF    | CCT   | LM    | COLOR  |
|--------|-------|-------|--------|
| 366102 | 2700K | 430lm | blanco |
| 366100 | 4000K | 450lm | blanco |
| 366104 | 5500K | 470lm | blanco |
| 366103 | 2700K | 430lm | níquel |
| 366101 | 4000K | 450lm | níquel |
| 366105 | 5500K | 470lm | níquel |



**HOLE | EMPOTRABLE | LED SMD 12W | 90-265V ~50-60Hz**

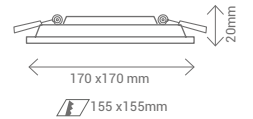

AL + AC



| REF    | CCT   | LM    | COLOR  |
|--------|-------|-------|--------|
| 366120 | 2700K | 865lm | blanco |
| 366118 | 4000K | 910lm | blanco |
| 366122 | 5500K | 955lm | blanco |
| 366121 | 2700K | 865lm | níquel |
| 366119 | 4000K | 910lm | níquel |
| 366123 | 5500K | 955lm | níquel |

**HOLE | EMPOTRABLE | LED SMD 18W | 90-265V ~50-60Hz**

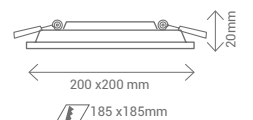

AL + AC



| REF    | CCT   | LM     | COLOR  |
|--------|-------|--------|--------|
| 366126 | 2700K | 1425lm | blanco |
| 366124 | 4000K | 1500lm | blanco |
| 366128 | 5500K | 1600lm | blanco |
| 366127 | 2700K | 1425lm | níquel |
| 366125 | 4000K | 1500lm | níquel |
| 366129 | 5500K | 1625lm | níquel |

**SURF | PLAFÓN | LED SMD 6W | 90-265V ~50-60Hz**



AL



| REF    | CCT   | LM    | COLOR  |
|--------|-------|-------|--------|
| 100825 | 2700K | 430lm | blanco |
| 100809 | 4000K | 450lm | blanco |
| 101029 | 5500K | 470lm | blanco |
| 100852 | 2700K | 430lm | níquel |
| 100898 | 4000K | 450lm | níquel |
| 101068 | 5500K | 470lm | níquel |

**SURF | PLAFÓN | LED SMD 12W | 90-265V ~50-60Hz**



AL



| REF    | CCT   | LM    | COLOR  |
|--------|-------|-------|--------|
| 100826 | 2700K | 865lm | blanco |
| 100807 | 4000K | 910lm | blanco |
| 101031 | 5500K | 955lm | blanco |
| 100854 | 2700K | 865lm | níquel |
| 100899 | 4000K | 910lm | níquel |
| 101069 | 5500K | 955lm | níquel |



**SURF | PLAFÓN | LED SMD 18W | 90-265V ~50-60Hz**



AL



| REF    | CCT   | LM     | COLOR  |
|--------|-------|--------|--------|
| 100827 | 2700K | 1425lm | blanco |
| 100805 | 4000K | 1500lm | blanco |
| 100912 | 5500K | 1600lm | blanco |
| 100894 | 2700K | 1425lm | níquel |
| 101064 | 4000K | 1500lm | níquel |
| 101070 | 5500K | 1625lm | níquel |



**SURF | PLAFÓN | LED SMD 6W | 90-265V ~50-60Hz**



AL



| REF    | CCT   | LM    | COLOR  |
|--------|-------|-------|--------|
| 100945 | 2700K | 430lm | blanco |
| 100810 | 4000K | 450lm | blanco |
| 101027 | 5500K | 470lm | blanco |
| 100895 | 2700K | 430lm | níquel |
| 101065 | 4000K | 450lm | níquel |
| 101071 | 5500K | 470lm | níquel |

**SURF | PLAFÓN | LED SMD 12W | 90-265V ~50-60Hz**



AL



| REF    | CCT   | LM    | COLOR  |
|--------|-------|-------|--------|
| 100948 | 2700K | 865lm | blanco |
| 100808 | 4000K | 910lm | blanco |
| 101030 | 5500K | 955lm | blanco |
| 100896 | 2700K | 865lm | níquel |
| 101066 | 4000K | 910lm | níquel |
| 101072 | 5500K | 955lm | níquel |



**SURF | PLAFÓN | LED SMD 18W | 90-265V ~50-60Hz**



AL



| REF    | CCT   | LM     | COLOR  |
|--------|-------|--------|--------|
| 100943 | 2700K | 1425lm | blanco |
| 100806 | 4000K | 1500lm | blanco |
| 101028 | 5500K | 1525lm | blanco |
| 100897 | 2700K | 1425lm | níquel |
| 101067 | 4000K | 1500lm | níquel |
| 101073 | 5500K | 1625lm | níquel |





**SURF | PLAFÓN | LED SMD 30W | 90-265V ~50-60Hz**



AL



| REF    | CCT   | LM     | COLOR  |
|--------|-------|--------|--------|
| 101252 | 4000K | 2400lm | blanco |
| 101054 | 4000K | 2400lm | níquel |



**SURF | PLAFÓN | LED SMD 30W | 90-265V~50-60Hz**

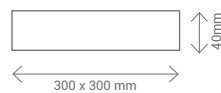

AL

| REF    | CCT   | LM     | COLOR  |
|--------|-------|--------|--------|
| 100824 | 4000K | 2400lm | blanco |
| 101074 | 4000K | 2400lm | níquel |



# SENSE



SENSE | PLAFON | LED SMD 18W | 220-240V ~50-60Hz

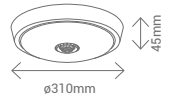

| REF    | CCT   | LM     | COLOR  |
|--------|-------|--------|--------|
| 101024 | 4000K | 1440lm | blanco |



**Área de detección: ajustable 4-6m.**  
**Tiempo de detección: ajustable 5-200s.**  
**Flujo de luz: ajustable.**

Sensing distance: adjustable 4-6m.  
 Delaying time: adjustable 5-200s.  
 Light flux: adjustable.

Zone de détection: ajustable 4-6m.  
 Temps de détection: ajustable 5-200s.  
 Flux de lumière: ajustable

Área de detecção: ajustável 4-6m.  
 Tempo de detecção: 5-200s ajustável.  
 Fluxo de luz: ajustável.



# FULL



FULL | PLAFON | LED SMD 24W | 220-240V ~50-60Hz

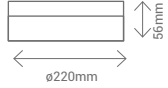

| REF    | CCT   | LM     | COLOR  |
|--------|-------|--------|--------|
| 101223 | 4000K | 2000lm | blanco |

FULL | PLAFON | LED SMD 24W | 220-240V ~50-60Hz

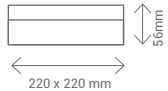

| REF    | CCT   | LM     | COLOR  |
|--------|-------|--------|--------|
| 101220 | 4000K | 2000lm | blanco |



# T W I S





**TWIS | PLAFON | LED SMD18+6W | 100-240V ~50-60Hz**

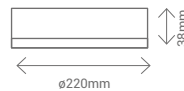

AL + A

| REF    | CCT   | LM         | COLOR  |
|--------|-------|------------|--------|
| 101225 | 4000K | 1400+300lm | blanco |

**TWIS | PLAFON | LED SMD18+6W | 100-240V ~50-60Hz**

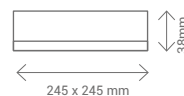

AL + A

| REF    | CCT   | LM         | COLOR  |
|--------|-------|------------|--------|
| 101226 | 4000K | 1400+300lm | blanco |

**TWIS | EMPOTRABLE | LED SMD18+6W | 100-240V ~50-60Hz**

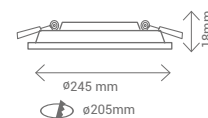

AL + A

| REF    | CCT   | LM         | COLOR  |
|--------|-------|------------|--------|
| 101224 | 4000K | 1400+300lm | blanco |



**Central**  
Middle  
Centrale  
Central



**Lateral**  
Sideways  
Latérale  
Lateral



**Combinada**  
Mixed  
Combiné  
Combinado

# HOLEGLAS



**HOLEGLAS | EMPOTRABLE | LED SMD 6W | 85-265V ~50-60Hz**

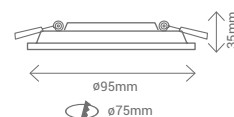

AL + G

| REF    | CCT   | LM    | COLOR  |
|--------|-------|-------|--------|
| 101060 | 4000K | 390lm | blanco |

**HOLEGLAS | EMPOTRABLE | LED SMD 12W | 85-265V ~50-60Hz**



AL + G

| REF    | CCT   | LM    | COLOR  |
|--------|-------|-------|--------|
| 101061 | 4000K | 890lm | blanco |

**HOLEGLAS | EMPOTRABLE | LED SMD 18W | 85-265V ~50-60Hz**

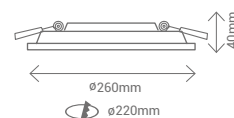

AL + G

| REF    | CCT   | LM    | COLOR  |
|--------|-------|-------|--------|
| 101062 | 4000K | 1600m | blanco |



# STRIP LED PROFESSIONAL



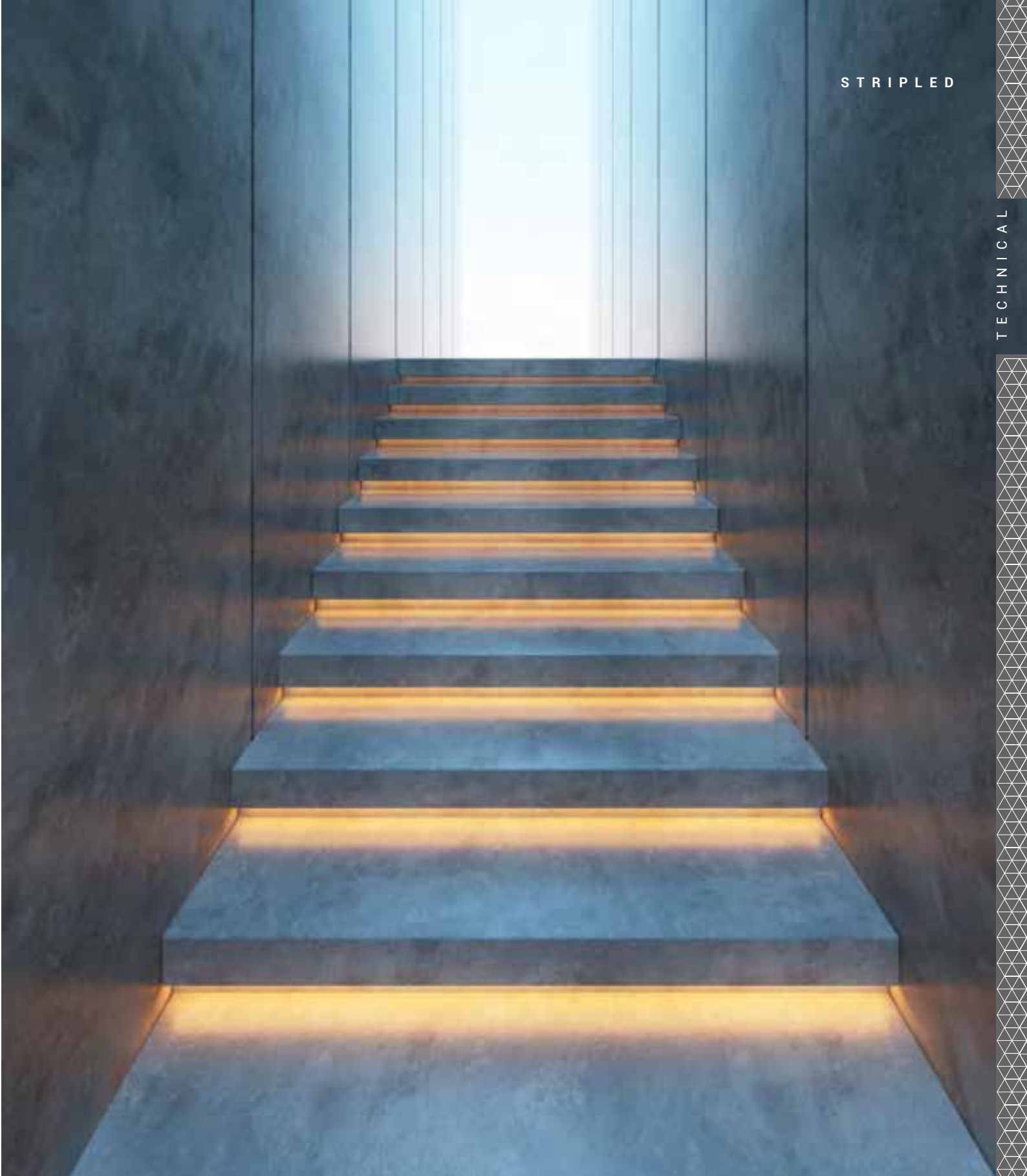

**STRIPLED PRO 24V | 240LED/m SMD | 19,2W/m**



| REF                           | m | REF                           | m   |
|-------------------------------|---|-------------------------------|-----|
| 24125 / 24020 / 24730 / 24630 | 1 | 24010 / 24100 / 24710 / 24680 | 5   |
| 24135 / 24035 / 24740 / 24640 | 1 | 24150 / 24350 / 24715 / 24615 | 7.5 |
| 24060                         | 3 | 24200 / 24720 / 24620         | 10  |
| 24175 / 24780 / 24680         | 3 | 24250 / 24725 / 24625         | 13* |



40mm

| REF           | CCT   | LM       | COLOR  |
|---------------|-------|----------|--------|
| <b>100736</b> | 2300k | 1200lm/m | blanco |
| <b>100737</b> | 2800K | 1440lm/m | blanco |
| <b>100738</b> | 4000K | 1560lm/m | blanco |
| <b>101736</b> | 6500K | 1680lm/m | blanco |

\* Necesario amplificador



**STRIPILED 24V | 60LED/m SMD | 4,8W/m**



| REF                           | m   | REF                           | m   |
|-------------------------------|-----|-------------------------------|-----|
| 24125 / 24020 / 24730 / 24630 | 5   | 24010 / 24100 / 24710 / 24680 | 20* |
| 24135 / 24035 / 24740 / 24640 | 7   | 24150 / 24350 / 24715 / 24615 | 31* |
| 24060                         | 12* | 24200 / 24720 / 24620         | 41* |
| 24175 / 24780 / 24680         | 15* | 24250 / 24725 / 24625         | 51* |

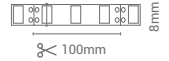

| REF    | CCT   | LM      | COLOR  |
|--------|-------|---------|--------|
| 108977 | 2700k | 340lm/m | blanco |
| 108978 | 4000K | 360lm/m | blanco |

**STRIPILED 24V | 60LED/m SMD | 14,4W/m**



| REF                           | m | REF                           | m   |
|-------------------------------|---|-------------------------------|-----|
| 24125 / 24020 / 24730 / 24630 | 1 | 24010 / 24100 / 24710 / 24680 | 65  |
| 24135 / 24035 / 24740 / 24640 | 2 | 24150 / 24350 / 24715 / 24615 | 10  |
| 24060                         | 4 | 24200 / 24720 / 24620         | 13* |
| 24175 / 24780 / 24680         | 5 | 24250 / 24725 / 24625         | 17* |

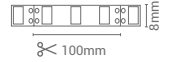

| REF    | CCT   | LM      | COLOR  |
|--------|-------|---------|--------|
| 108979 | 2700k | 940lm/m | blanco |
| 108980 | 4000K | 960lm/m | blanco |

**STRIPILED 24V | 60LED/m RGB | 14,4W/m**



| REF                           | m | REF                           | m   |
|-------------------------------|---|-------------------------------|-----|
| 24125 / 24020 / 24730 / 24630 | 1 | 24010 / 24100 / 24710 / 24680 | 65  |
| 24135 / 24035 / 24740 / 24640 | 2 | 24150 / 24350 / 24715 / 24615 | 10  |
| 24060                         | 4 | 24200 / 24720 / 24620         | 13* |
| 24175 / 24780 / 24680         | 5 | 24250 / 24725 / 24625         | 17* |



| REF    | CCT | COLOR  |
|--------|-----|--------|
| 108741 | RGB | blanco |

**STRIPILED 24V | 60LED/m SMD | 4,8W/m**



| REF                           | m   | REF                           | m   |
|-------------------------------|-----|-------------------------------|-----|
| 24125 / 24020 / 24730 / 24630 | 5   | 24010 / 24100 / 24710 / 24680 | 20* |
| 24135 / 24035 / 24740 / 24640 | 7   | 24150 / 24350 / 24715 / 24615 | 31* |
| 24060                         | 12* | 24200 / 24720 / 24620         | 41* |
| 24175 / 24780 / 24680         | 15* | 24250 / 24725 / 24625         | 51* |



| REF    | CCT   | LM      | COLOR  |
|--------|-------|---------|--------|
| 108936 | 2700k | 290lm/m | blanco |
| 108937 | 4000K | 300lm/m | blanco |

**STRIPILED 24V | 60LED/m SMD | 14,4W/m**

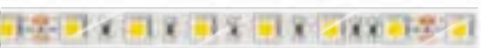

| REF                           | m | REF                           | m   |
|-------------------------------|---|-------------------------------|-----|
| 24125 / 24020 / 24730 / 24630 | 1 | 24010 / 24100 / 24710 / 24680 | 65  |
| 24135 / 24035 / 24740 / 24640 | 2 | 24150 / 24350 / 24715 / 24615 | 10  |
| 24060                         | 4 | 24200 / 24720 / 24620         | 13* |
| 24175 / 24780 / 24680         | 5 | 24250 / 24725 / 24625         | 17* |

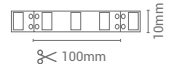

| REF    | CCT   | LM      | COLOR  |
|--------|-------|---------|--------|
| 108939 | 2700k | 940lm/m | blanco |
| 108940 | 4000K | 960lm/m | blanco |

**STRIPILED 24V | 60LED/m RGB | 14,4W/m**



| REF                           | m | REF                           | m   |
|-------------------------------|---|-------------------------------|-----|
| 24125 / 24020 / 24730 / 24630 | 1 | 24010 / 24100 / 24710 / 24680 | 65  |
| 24135 / 24035 / 24740 / 24640 | 2 | 24150 / 24350 / 24715 / 24615 | 10  |
| 24060                         | 4 | 24200 / 24720 / 24620         | 13* |
| 24175 / 24780 / 24680         | 5 | 24250 / 24725 / 24625         | 17* |

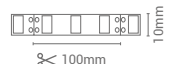

| REF    | CCT | COLOR  |
|--------|-----|--------|
| 108941 | RGB | blanco |

**STRIPLED | CONECTOR UNION | 8mm**



| REF   | sec.Ø                 | Lmm |
|-------|-----------------------|-----|
| 80606 | 2x0,35mm <sup>2</sup> | -   |

**STRIPLED | CABLE CONECTOR UNION | 8mm**



| REF   | sec.Ø                 | Lmm |
|-------|-----------------------|-----|
| 80604 | 2x0,35mm <sup>2</sup> | 140 |

**STRIPLED | CABLE CONECTOR SALIDA | 8mm**



| REF   | sec.Ø                 | Lmm |
|-------|-----------------------|-----|
| 80608 | 2x0,35mm <sup>2</sup> | 140 |

**STRIPLED | CONECTOR UNION | 10mm**



| REF   | sec.Ø                 | Lmm |
|-------|-----------------------|-----|
| 80607 | 2x0,35mm <sup>2</sup> | -   |

**STRIPLED | CABLE CONECTOR UNION | 10mm**



| REF   | sec.Ø                 | Lmm |
|-------|-----------------------|-----|
| 80609 | 2x0,35mm <sup>2</sup> | 140 |

**STRIPLED | CABLE CONECTOR SALIDA | 10mm**



| REF   | sec.Ø                 | Lmm |
|-------|-----------------------|-----|
| 80605 | 2x0,35mm <sup>2</sup> | 140 |

**STRIPLED | CONECTOR UNION RGB | 10mm**



| REF   | sec.Ø                 | Lmm |
|-------|-----------------------|-----|
| 80611 | 4x0,35mm <sup>2</sup> | -   |

**STRIPLED | CABLE CONECTOR UNION RGB | 10mm**



| REF   | sec.Ø                 | Lmm |
|-------|-----------------------|-----|
| 80612 | 4x0,35mm <sup>2</sup> | 140 |

**STRIPLED | CABLE CONECTOR SALIDA RGB | 10mm**



| REF   | sec.Ø                 | Lmm |
|-------|-----------------------|-----|
| 80610 | 4x0,35mm <sup>2</sup> | 140 |

**STRIPLED | CONECTOR RGB |**



| REF   | sec. | Lmm |
|-------|------|-----|
| 80634 | 10mm | -   |

**STRIPLED | CINTA ADHESIVA |**



| REF   | sec. | Lmm  |
|-------|------|------|
| 80602 | 8mm  | 3000 |
| 80613 | 10mm | 3000 |



PERFILES | SUPERFICIE | 2M



| REF    | PRODUCT | hmm  | COLOR        |
|--------|---------|------|--------------|
| 500007 | 1       | 7mm  | aluminio     |
| 501007 | 1       | 7mm  | blanco       |
| 502007 | 1       | 7mm  | negro        |
| 500015 | 1       | 15mm | aluminio     |
| 501015 | 1       | 15mm | blanco       |
| 502015 | 1       | 15mm | negro        |
| 050300 | 2       | -    | transparente |
| 050301 | 2       | -    | mate         |
| 050302 | 2       | -    | opaco        |
| 050407 | 3       | 7mm  | gris         |
| 050408 | 4       | 7mm  | gris         |
| 050409 | 3       | 7mm  | blanco       |
| 050419 | 4       | 7mm  | blanco       |
| 050405 | 3       | 15mm | gris         |
| 050406 | 4       | 15mm | gris         |
| 050410 | 3       | 15mm | blanco       |
| 050420 | 4       | 15mm | blanco       |
| 050600 | 5       | 7mm  | blanco       |
| 050602 | 5       | 15mm | blanco       |
| 050612 | 5       | 15mm | transparente |
| 050608 | 6       | 7mm  | blanco       |
| 050601 | 6       | 15mm | blanco       |

PERFILES | EMPOTRABLE | 2M

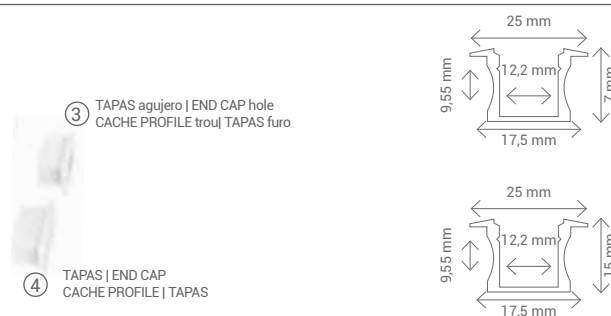

| REF    | PRODUCT | hmm  | COLOR        |
|--------|---------|------|--------------|
| 500017 | 1       | 7mm  | aluminio     |
| 500115 | 1       | 15mm | aluminio     |
| 050300 | 2       | -    | transparente |
| 050301 | 2       | -    | mate         |
| 050302 | 2       | -    | opaco        |
| 050417 | 3       | 7mm  | gris         |
| 050418 | 4       | 7mm  | gris         |
| 050415 | 3       | 15mm | gris         |
| 050416 | 4       | 15mm | gris         |

## PERFILES | ESQUINA | 2M

② DIFUSOR | DIFFUSER  
DIFFUSEUR | DIFUSOR

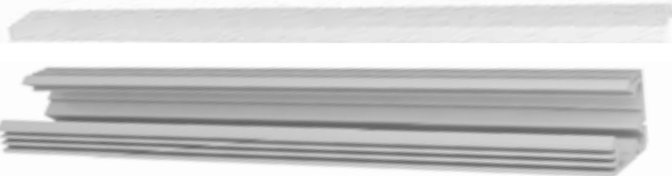

① PERFILES | PROFILES |  
PROFILES | PERFILES

③ TAPAS agujero | END CAP hole  
CACHE PROFILE trou | TAPAS furo

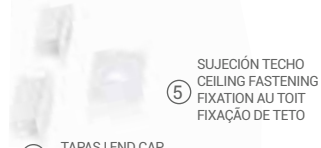

⑤ SUJECIÓN TECHO  
CEILING FASTENING  
FIXATION AU TOIT  
FIXAÇÃO DE TETO

④ TAPAS | END CAP  
CACHE PROFILE | TAPAS

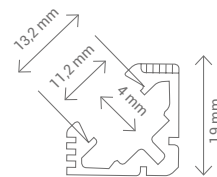

| REF    | PRODUCT | hmm  | COLOR         |
|--------|---------|------|---------------|
| 500011 | 1       | 19mm | aluminio      |
| 501011 | 1       | 19mm | blanco        |
| 502011 | 1       | 19mm | negro         |
| 050303 | 2       | -    | transparentee |
| 050304 | 2       | -    | mate          |
| 050305 | 2       | -    | opaco         |
| 050434 | 3       | 19mm | gris          |
| 050435 | 4       | 19mm | gris          |
| 050412 | 3       | 19mm | blanco        |
| 050422 | 4       | 19mm | blanco        |
| 050603 | 5       | 15mm | blanco        |

## DIFUSOR | DIFFUSER | DIFFUSEUR | DIFUSOR



**Transparente** | Transparente  
Transparente | Transparente

**Translúcido** | Translucent  
Translucide | **Translúcido**

**MATE** | Mate  
MAT | MATE

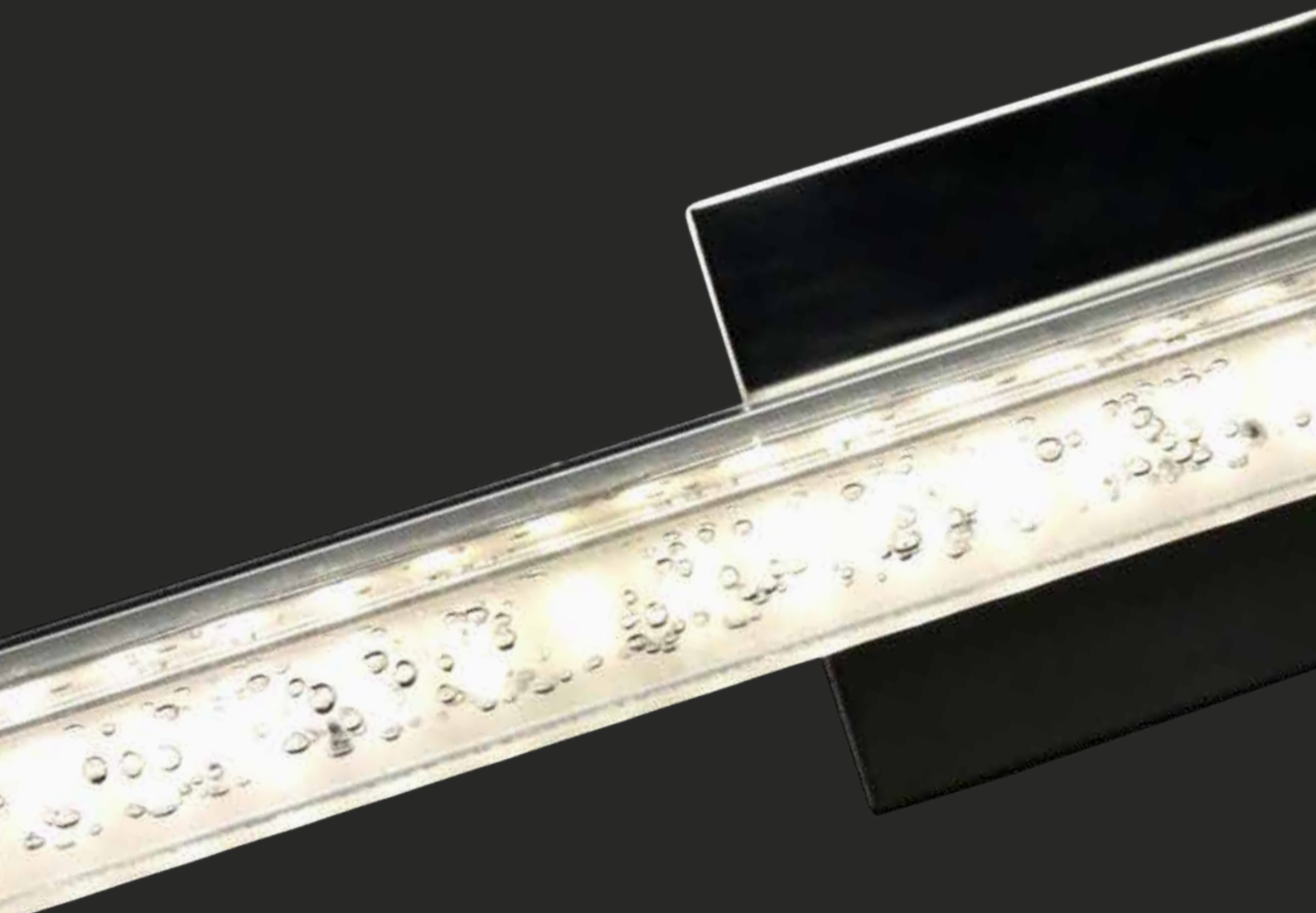

**BATHROOM**



# DOUCHE



## DOUCHE | DOWNLIGHT | LED SMD 7W | 200-240V ~50-60Hz

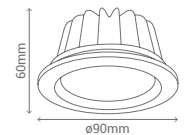

AL



| REF    | CCT   | LM  | COLOR  |
|--------|-------|-----|--------|
| 112050 | 4000K | 560 | blanco |

## DOUCHE | DOWNLIGHT | LED SMD 7W | 200-240V ~50-60Hz

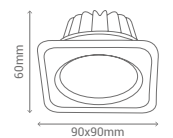

AL



| REF    | CCT   | LM  | COLOR  |
|--------|-------|-----|--------|
| 112052 | 4000K | 560 | blanco |



# AQUARUM





**AQUARUM** | DOWNLIGHT | LED SMD 20W | 85-265V ~50-60Hz

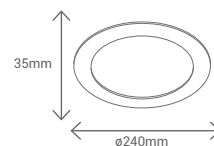

AL + AC

35.000h

-5~+40°C

PF 0.50



IP 65

120°



A

CRI 80

ø225mm

| REF    | CCT   | LM   | COLOR  |
|--------|-------|------|--------|
| 940540 | 4000K | 1400 | blanco |

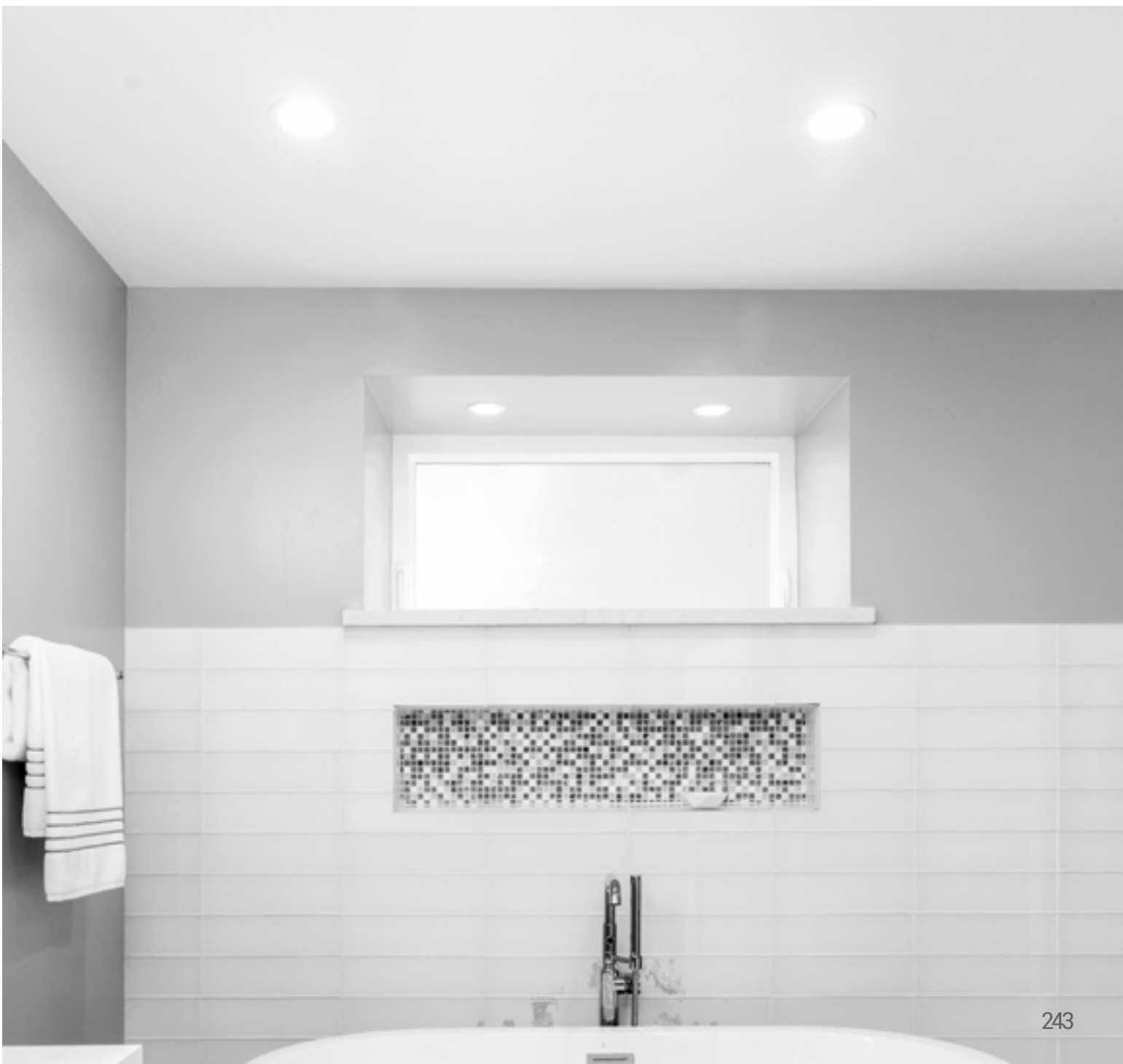

# FAST

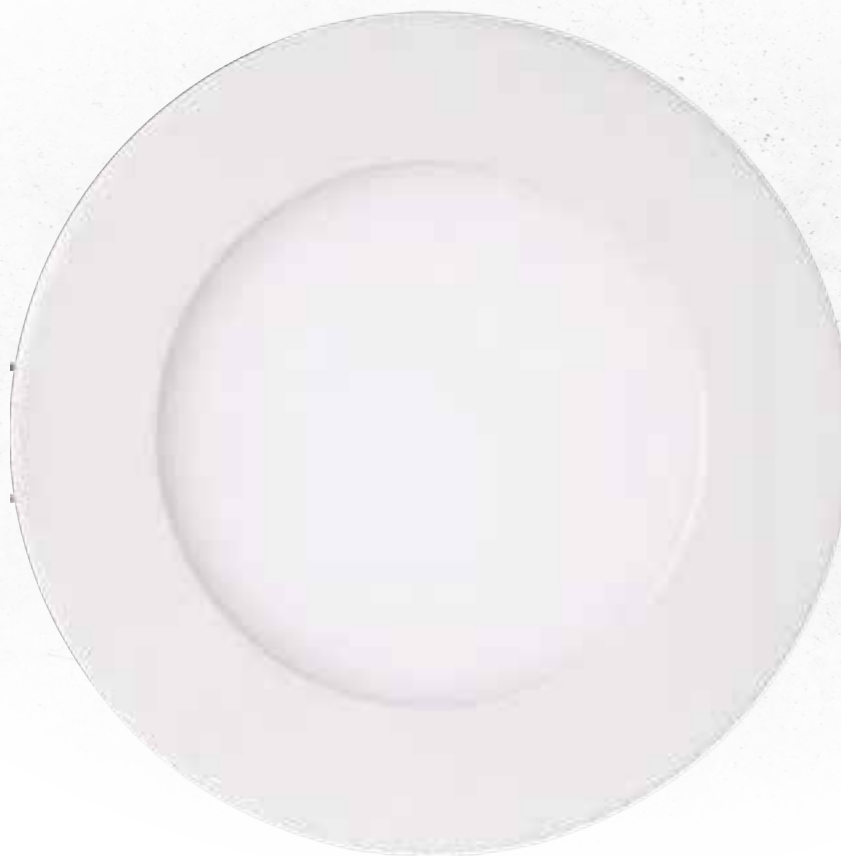

**FAST | DOWNLIGHT | LED SMD 4W | 110-240V ~50-60Hz**

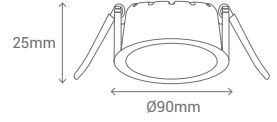

AL + AC  
30.000h 5~+40°C PF 0.50 IP 44 120° A CRI 80 ø75mm

| REF    | CCT   | LM  | COLOR  |
|--------|-------|-----|--------|
| 365093 | 3000K | 250 | blanco |
| 365095 | 4000K | 300 | blanco |

**FAST | DOWNLIGHT | LED SMD 18W | 110-240V ~50-60Hz**

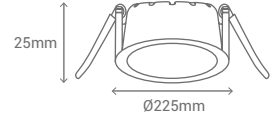

AL + AC  
30.000h 5~+40°C PF 0.50 IP 44 120° A CRI 80 ø210mm

| REF    | CCT   | LM   | COLOR  |
|--------|-------|------|--------|
| 365094 | 3000K | 1500 | blanco |
| 365096 | 4000K | 1600 | blanco |



# NATURE



NATURE | DOWNLIGHT | LED SMD 18W | 220-240V ~50-60Hz

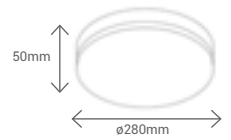

| REF    | CCT   | LM   | COLOR  |
|--------|-------|------|--------|
| 111119 | 4000K | 1200 | blanco |



PLURIEL



PLURIEL | PLAFÓN | LED SMD 12W | 110-240V~50-60Hz

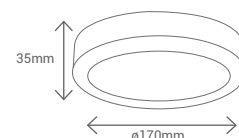

AL + AC



| REF    | CCT   | LM  | COLOR  |
|--------|-------|-----|--------|
| 112923 | 4000K | 910 | blanco |
| 112091 | 4000K | 910 | níquel |

PLURIEL | PLAFÓN | LED SMD 18W | 110-240V~50-60Hz

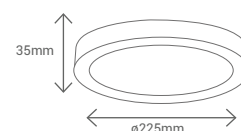

AL + AC



| REF    | CCT   | LM   | COLOR  |
|--------|-------|------|--------|
| 112915 | 4000K | 1500 | blanco |
| 102094 | 4000K | 1500 | níquel |

PLURIEL | PLAFÓN | LED SMD 12W | 110-240V~50-60Hz

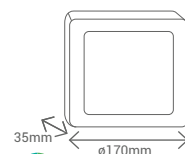
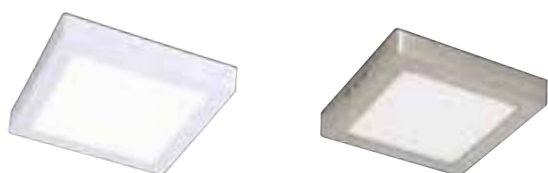

AL + AC



| REF    | CCT   | LM  | COLOR  |
|--------|-------|-----|--------|
| 112926 | 4000K | 910 | blanco |
| 112051 | 4000K | 910 | níquel |

PLURIEL | PLAFÓN | LED SMD 18W | 110-240V~50-60Hz

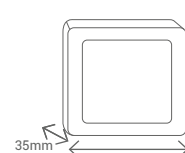
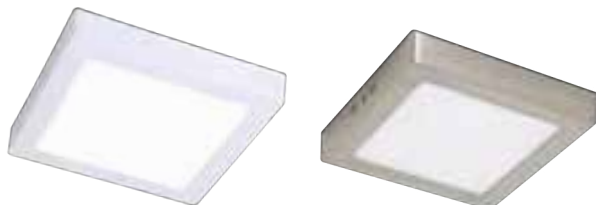

AL + AC



| REF    | CCT   | LM   | COLOR  |
|--------|-------|------|--------|
| 112916 | 4000K | 1500 | blanco |
| 102039 | 4000K | 1500 | níquel |





# CURVES



**CURVES | APLIQUE | LED SMD 7W | 220-240V ~50-60Hz**

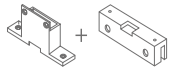

**Fijación en espejo** | Possible to use on a mirror |  
Peut être fixé à un miroir | Fixação em espelho disponível



AL + AC

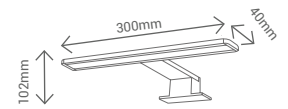

| REF    | CCT   | LM  | COLOR  |
|--------|-------|-----|--------|
| 142000 | 4000K | 560 | chromo |

**CURVES | APLIQUE | LED SMD 10W | 220-240V ~50-60Hz**

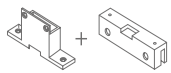

**Fijación en espejo** | Possible to use on a mirror |  
Peut être fixé à un miroir | Fixação em espelho disponível



AL + AC

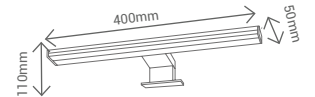

| REF    | CCT   | LM  | COLOR  |
|--------|-------|-----|--------|
| 142001 | 4000K | 800 | chromo |



# B U L A



**BULA** | APLIQUE | LED SMD 12W | 220-240V ~50-60Hz

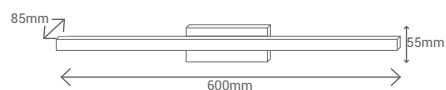

AL + AC

30.000h

-5~+40°C

PF 0.55

IP 23

180°

A+

CRI 80

| REF    | CCT   | LM   | COLOR                 |
|--------|-------|------|-----------------------|
| 142010 | 4000K | 1120 | chromo + transparente |



# TUBES

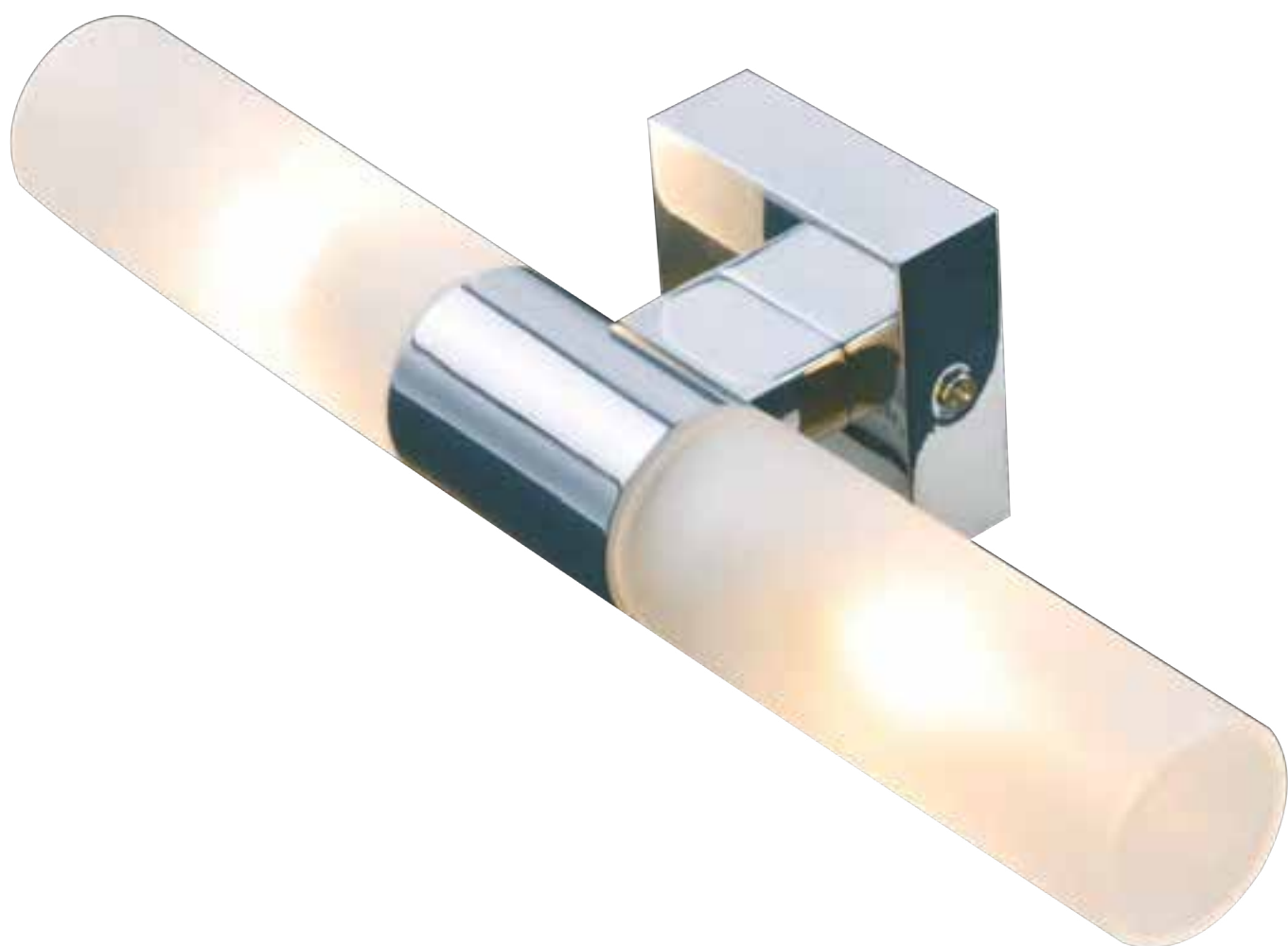

TUBES | APLIQUE | 2x40W G9 | 100-240V ~50-60Hz

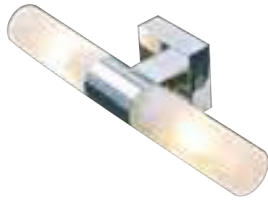

AL + AC

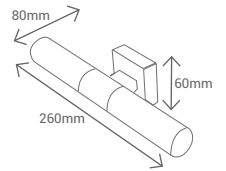

| REF    | W Máx. | CASQUILLO | COLOR |
|--------|--------|-----------|-------|
| 393326 | 2x40   | G9        | cromo |







O U T D O O R





# BEWATER



BEWATER | UNDERCABINET | LED SMD 25W | 220-240V~50-60Hz

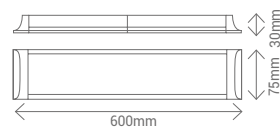

AL + PC



| REF    | CCT   | LM   | COLOR  |
|--------|-------|------|--------|
| 102021 | 4000K | 2175 | blanco |

BEWATER | UNDERCABINET | LED SMD 45W | 220-240V~50-60Hz

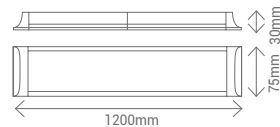

AL + PC



| REF    | CCT   | LM   | COLOR  |
|--------|-------|------|--------|
| 102022 | 4000K | 3800 | blanco |



# DEEP



2x58W  
TUBO FLUORESCENTE  
FLUORESCENT TUBE  
TUBE FLUORESCENT  
TUBO FLUORESCENTE

35W  
DEEP



Sustitución de instalación con pantallas estancas de tubo fluorescente por pantallas estancas de LED DEEP.

Replacement of installation with screenlights fluorescent tubes by LED screenlight DEEP.  
Remplacement d'une installation de étanches de tubes fluorescents pas des panneaux LED DEEP.  
Substituição da instalação das armaduras de tubos fluorescentes pelas armadura de LED DEEP.

DEEP | PANTALLAS LED | LED SMD 14W | 180-240V~50-60Hz



AC



| REF    | CCT   | LM   | COLOR  |
|--------|-------|------|--------|
| 101259 | 4000K | 1960 | blanco |
| 101260 | 6000K | 2050 | blanco |

DEEP | PANTALLAS LED | LED SMD 28W | 180-240V~50-60Hz



AC



| REF    | CCT   | LM   | COLOR  |
|--------|-------|------|--------|
| 101261 | 4000K | 3920 | blanco |
| 101262 | 6000K | 4100 | blanco |

DEEP | PANTALLAS LED | LED SMD 35W | 180-240V~50-60Hz

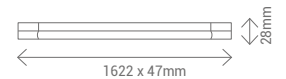

AC



| REF    | CCT   | LM   | COLOR  |
|--------|-------|------|--------|
| 101263 | 4000K | 4900 | blanco |
| 101264 | 6000K | 5080 | blanco |

DEEP | KIT DE SUSPENSIÓN |



| REF   | Lmm  | COLOR    |
|-------|------|----------|
| 50653 | 4900 | aluminio |



# TISA

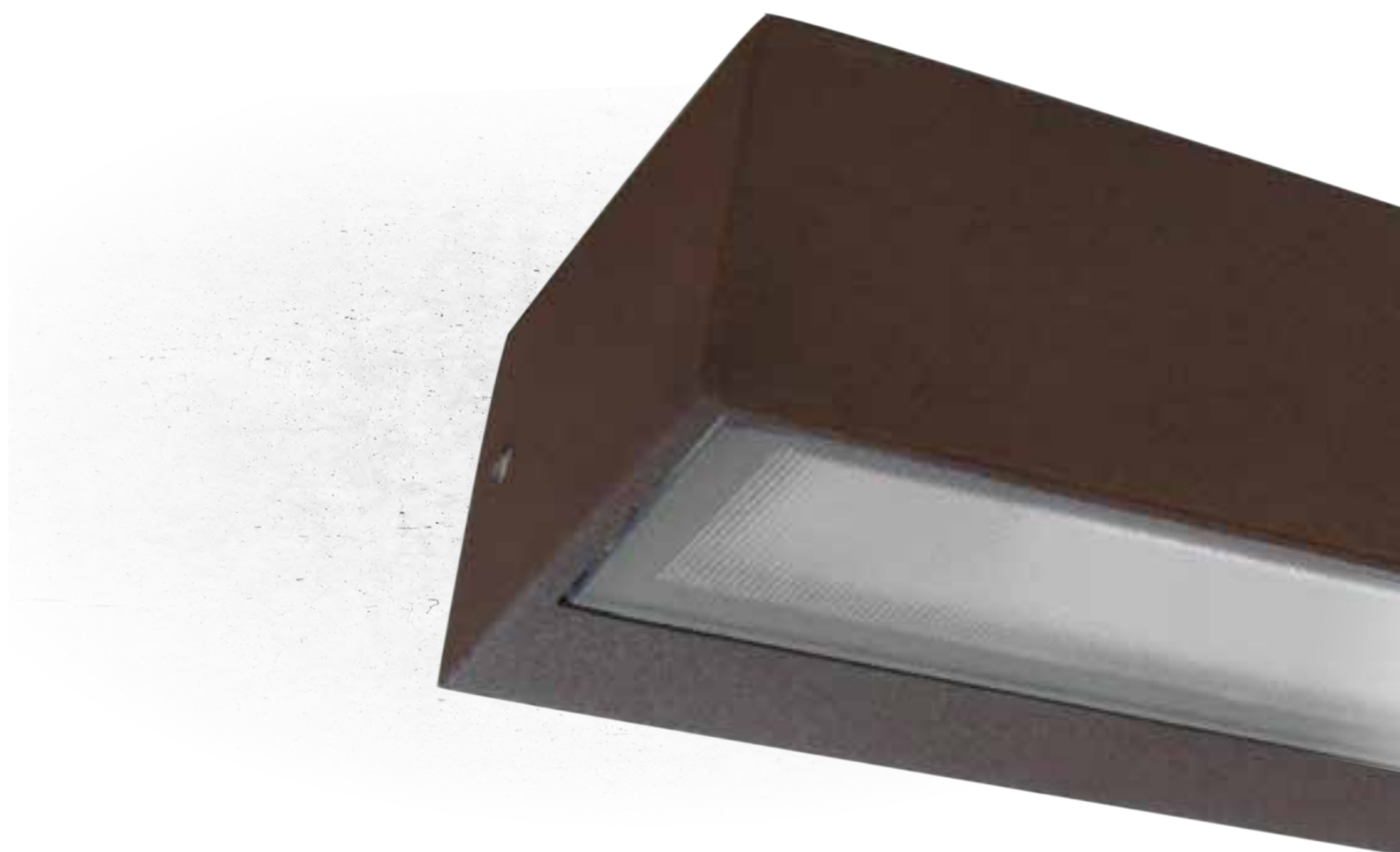



TISA | APLIQUE | LED SMD 1x12W | 220-240V~50-60Hz

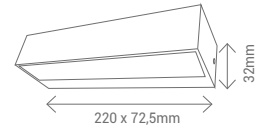
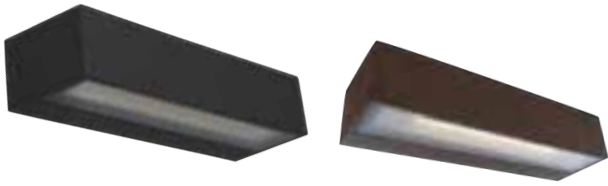

AL + AC



| REF    | CCT   | LM  | COLOR          |
|--------|-------|-----|----------------|
| 112272 | 3000K | 600 | gris antracita |
| 112972 | 4000K | 640 | gris antracita |
| 112358 | 3000K | 600 | acero cortén   |
| 112958 | 4000K | 640 | acero cortén   |

TISA | APLIQUE | LED SMD 2X8W | 220-240V~50-60Hz

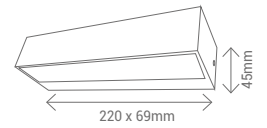
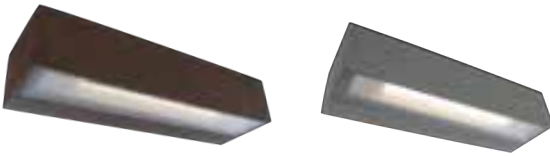

AL + AC



| REF    | CCT   | LM   | COLOR        |
|--------|-------|------|--------------|
| 112271 | 3000K | 1000 | acero cortén |
| 112287 | 3000K | 1000 | gris         |

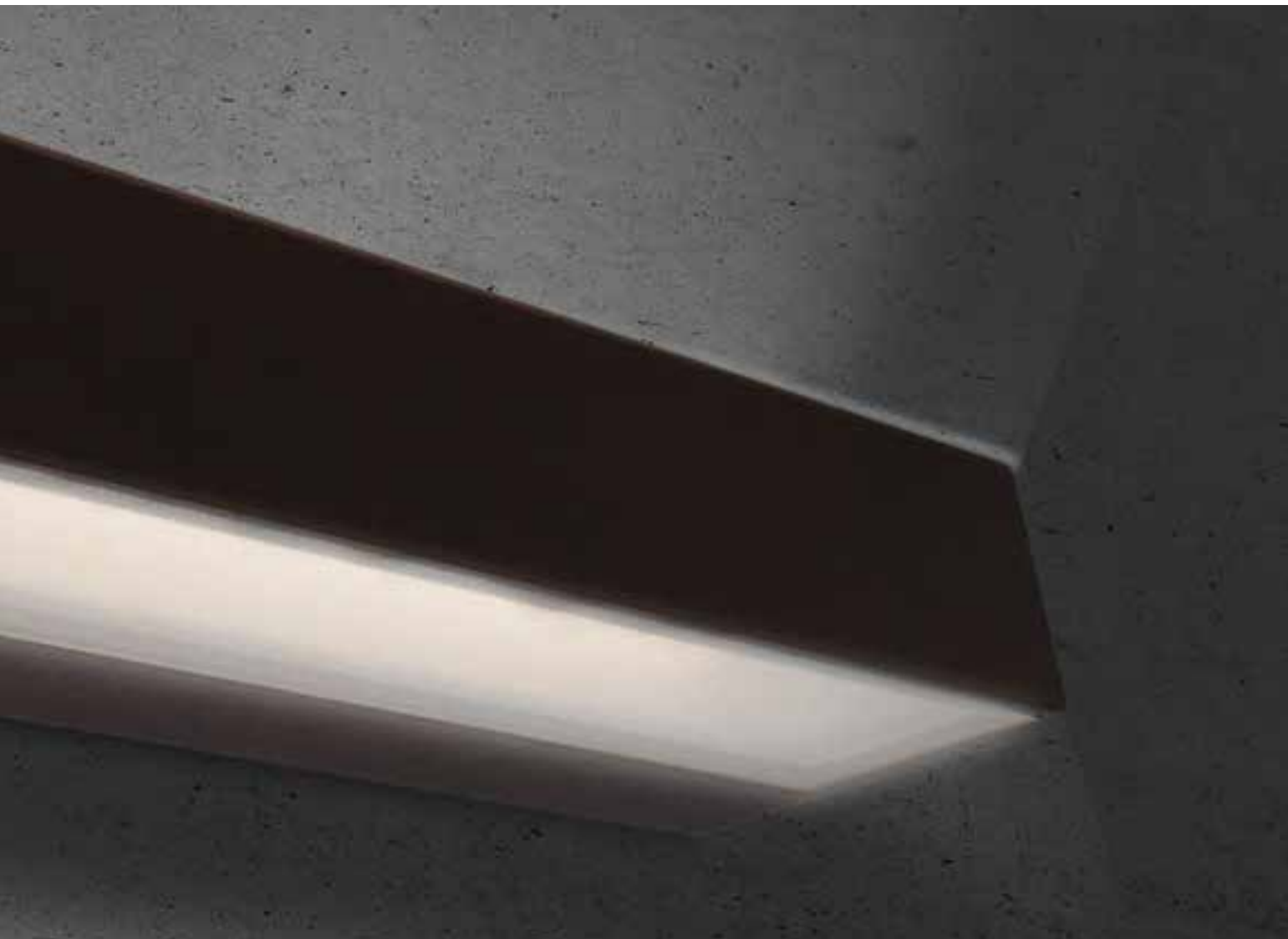



COLLECTION | 2019

PENN +



**PENN+ | WALL WASHER | LED SMD 18W | 24V DC 50-60Hz**



| DRIVER                        |     |                               |     |
|-------------------------------|-----|-------------------------------|-----|
| REF                           | pcs | REF                           | pcs |
| 24125 / 24020 / 24730 / 24630 | 1   | 24010 / 24100 / 24710 / 24680 | 5   |
| 24135 / 24035 / 24740 / 24640 | 1   | 24150 / 24350 / 24715 / 24615 | 8   |
| 24060                         | 3   | 24200 / 24720 / 24620         | 11* |
| 24175 / 24780 / 24680         | 3   | 24250 / 24725 / 24625         | 13* |

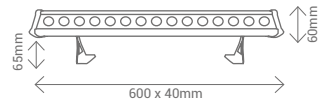

AL + G



| REF    | CCT   | LM     | COLOR           |
|--------|-------|--------|-----------------|
| 100795 | 2700K | 1150lm | aluminio/ negro |
| 102796 | 4000K | 1350lm | aluminio/ negro |

**PENN+ | WALL WASHER | LED SMD 18W | 24V DC 50-60Hz**



| DRIVER                        |     |                               |     |
|-------------------------------|-----|-------------------------------|-----|
| REF                           | pcs | REF                           | pcs |
| 24125 / 24020 / 24730 / 24630 | 1   | 24010 / 24100 / 24710 / 24680 | 5   |
| 24135 / 24035 / 24740 / 24640 | 1   | 24150 / 24350 / 24715 / 24615 | 8   |
| 24060                         | 3   | 24200 / 24720 / 24620         | 11* |
| 24175 / 24780 / 24680         | 3   | 24250 / 24725 / 24625         | 13* |

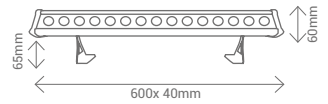

AL + G



| REF    | CCT | LM | COLOR           |
|--------|-----|----|-----------------|
| 102795 | RGB | -  | aluminio/ negro |

**PENN+ | WALL WASHER | LED SMD 36W | 24V DC 50-60Hz**



| DRIVER                        |     |                               |     |
|-------------------------------|-----|-------------------------------|-----|
| REF                           | pcs | REF                           | pcs |
| 24740 / 24640                 | 1   | 24150 / 24350 / 24715 / 24615 | 4   |
| 24060                         | 1   | 24200 / 24720 / 24620         | 5   |
| 24175 / 24780 / 24680         | 2   | 24250 / 24725 / 24625         | 6   |
| 24010 / 24100 / 24710 / 24610 | 2   |                               |     |

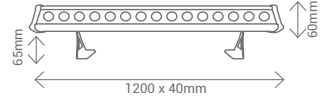

AL + G



| REF    | CCT   | LM     | COLOR           |
|--------|-------|--------|-----------------|
| 102798 | 2700K | 2250lm | aluminio/ negro |
| 102799 | 4000K | 2750lm | aluminio/ negro |

**PENN+ | WALL WASHER | LED SMD 36W | 24V DC 50-60Hz**



| DRIVER                        |     |                               |     |
|-------------------------------|-----|-------------------------------|-----|
| REF                           | pcs | REF                           | pcs |
| 24740 / 24640                 | 1   | 24150 / 24350 / 24715 / 24615 | 4   |
| 24060                         | 1   | 24200 / 24720 / 24620         | 5   |
| 24175 / 24780 / 24680         | 2   | 24250 / 24725 / 24625         | 6   |
| 24010 / 24100 / 24710 / 24610 | 2   |                               |     |

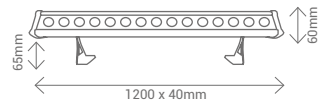

AL + G



| REF    | CCT | LM | COLOR           |
|--------|-----|----|-----------------|
| 102797 | RGB | -  | aluminio/ negro |

\*Necesario amplificador



**PENN** | ANTIREFLECTOR |



 artículo bajo pedido previo

|   | REF   | Lmm  |
|---|---|------|
|  |  | 600  |
|  |  | 1200 |

**PENN** | CONECTOR ♀ | IP66 0.5m



|   | REF   | Lmm |
|---|-------|-----|
|  | 10080 | 500 |

**PENN** | TAPON ♀ |



|   | REF   | Lmm |
|---|-------|-----|
|  | 10081 | -   |

**PENN** | TAPON | 65mm



|   | REF   | Lmm |
|---|-------|-----|
|  | 10083 | 65  |

**PENN** | FIJACIÓN | 37mm



|   | REF   | Lmm |
|---|-------|-----|
|  | 10084 | 37  |



# K A M A L



**KAMAL | APLIQUE | LED SMD 3W | 220-240V~50-60Hz**

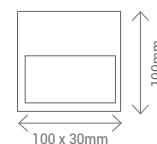

AL + AC



| REF    | CCT   | LM  | COLOR  |
|--------|-------|-----|--------|
| 113954 | 2700K | 175 | blanco |
| 113952 | 2700K | 175 | negro  |
| 113955 | 4000K | 200 | blanco |
| 113953 | 4000K | 200 | negro  |

**KAMAL | APLIQUE | LED SMD 8W | 220-240V~50-60Hz**



AL + AC



| REF    | CCT   | LM  | COLOR  |
|--------|-------|-----|--------|
| 113991 | 2700K | 400 | blanco |
| 113992 | 2700K | 400 | negro  |
| 113990 | 4000K | 480 | blanco |
| 113192 | 4000K | 480 | negro  |

**KAMAL | APLIQUE | LED SMD 4W | 220-240V~50-60Hz**



AL + AC



| REF    | CCT   | LM  | COLOR |
|--------|-------|-----|-------|
| 113188 | 4000K | 200 | negro |

**KAMAL | APLIQUE | LED SMD 6W | 220-240V~50-60Hz**

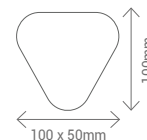

AL + AC



| REF    | CCT   | LM  | COLOR |
|--------|-------|-----|-------|
| 113256 | 4000K | 200 | negro |





COB FOUNT





COB FOUNT | APLIQUE | LED COB 4W | 90-260V~50-60Hz

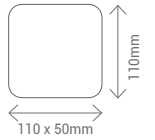

AL + AC

50,000h | -5~+40°C | PF 0.50 | IP 54 | 30° | A+ | CRI >80

| REF    | CCT   | LM  | COLOR       |
|--------|-------|-----|-------------|
| 111135 | 3000K | 360 | gris oscuro |

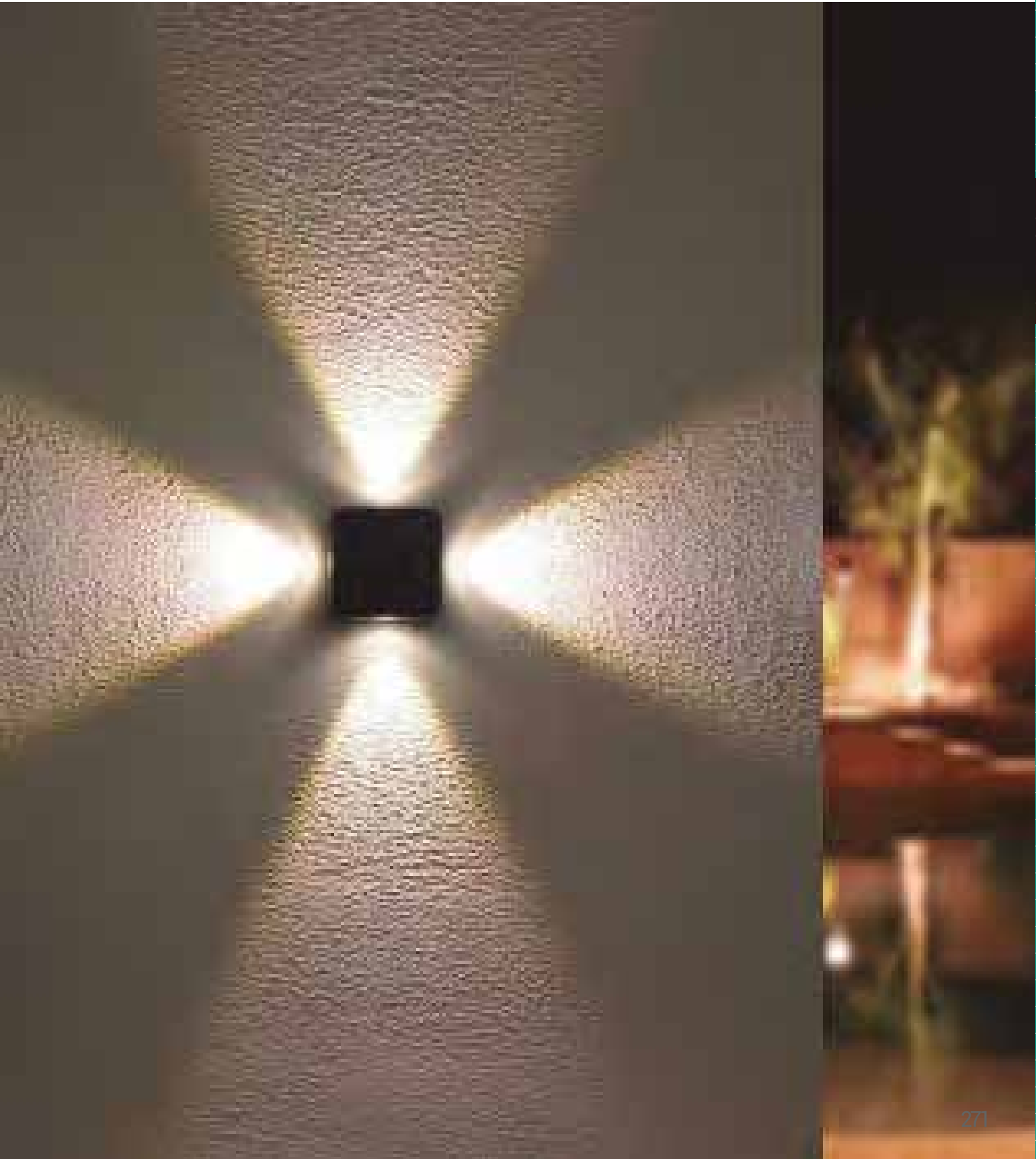

COB DEW



COB DEW

COB DEW | APLIQUE | LED COB 6W | 220-240V~50-60Hz



AL + G

10.000h

-5~+40°C

PF 0.50

IP 54

55°

A+

CRI >80

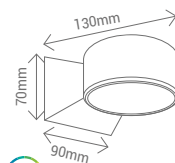

| REF    | CCT   | LM  | COLOR  |
|--------|-------|-----|--------|
| 111123 | 3000K | 360 | blanco |

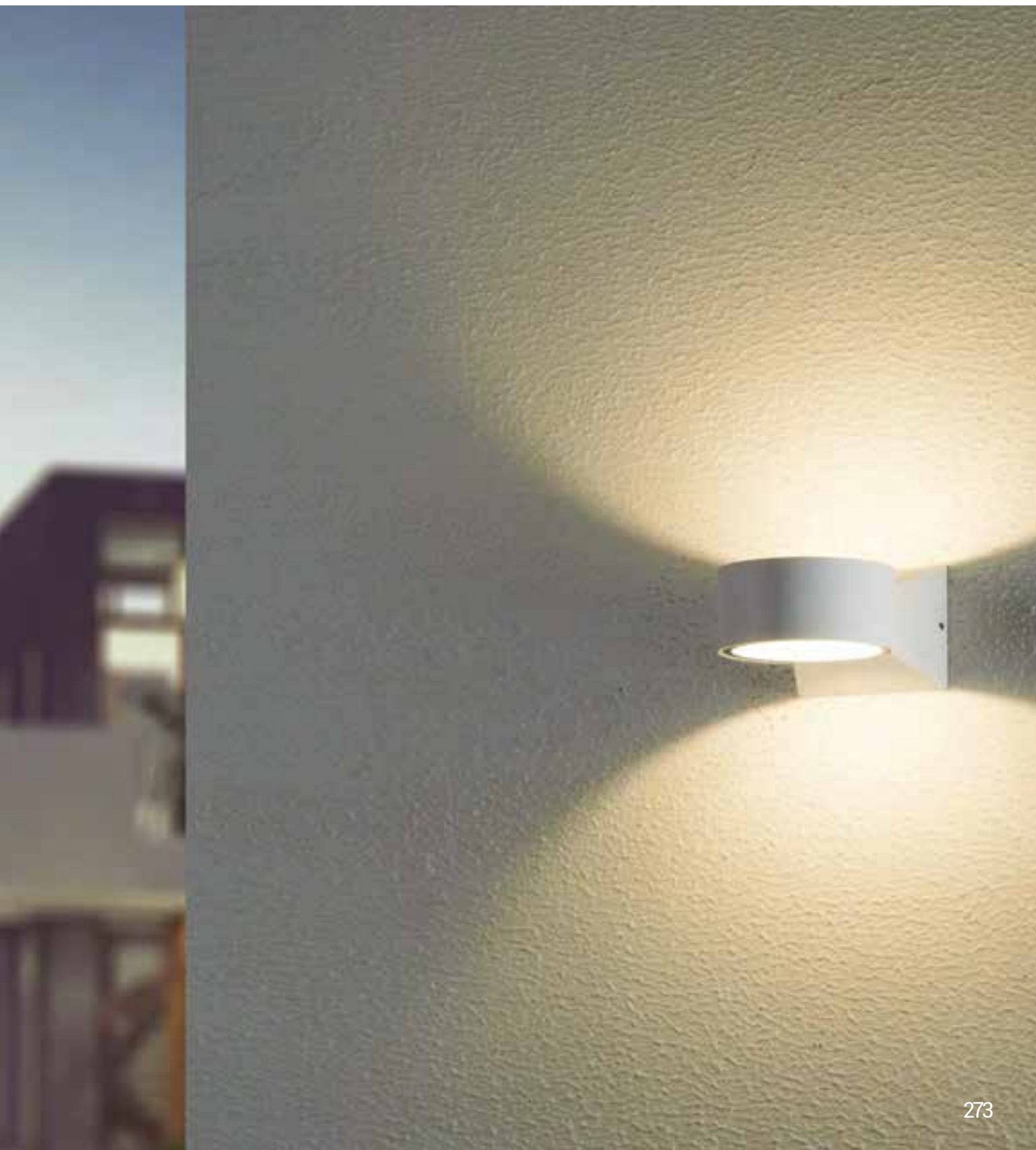

OUTDOOR

NEW ERA



NEW ERA | APLIQUE | LED SMD 2X6W | 220-240V~50-60Hz

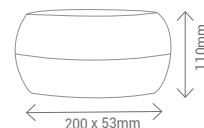

AL + AC

30.000h

-5~+40°C

PF 0.50

IP 54

A

CRI 80

| REF    | CCT   | LM  | COLOR  |
|--------|-------|-----|--------|
| 112208 | 3000K | 950 | blanco |

NEW ERA | APLIQUE | LED SMD 2X6W | 220-240V~50-60Hz

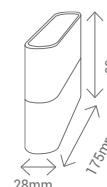

AL + AC

30.000h

-5~+40°C

PF 0.50

IP 54

A

CRI 80

| REF    | CCT   | LM  | COLOR  |
|--------|-------|-----|--------|
| 112180 | 3000K | 950 | blanco |



COB FROST





COB FROST | APLIQUE | LED COB 6W | 220-240V~50-60Hz



AL



A+

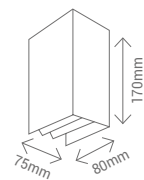

| REF    | CCT   | LM  | COLOR          |
|--------|-------|-----|----------------|
| 111188 | 3000K | 600 | gris antracita |
| 111189 | 3000K | 600 | blanco         |
| 111988 | 4000K | 630 | gris antracita |
| 111989 | 4000K | 630 | blanco         |

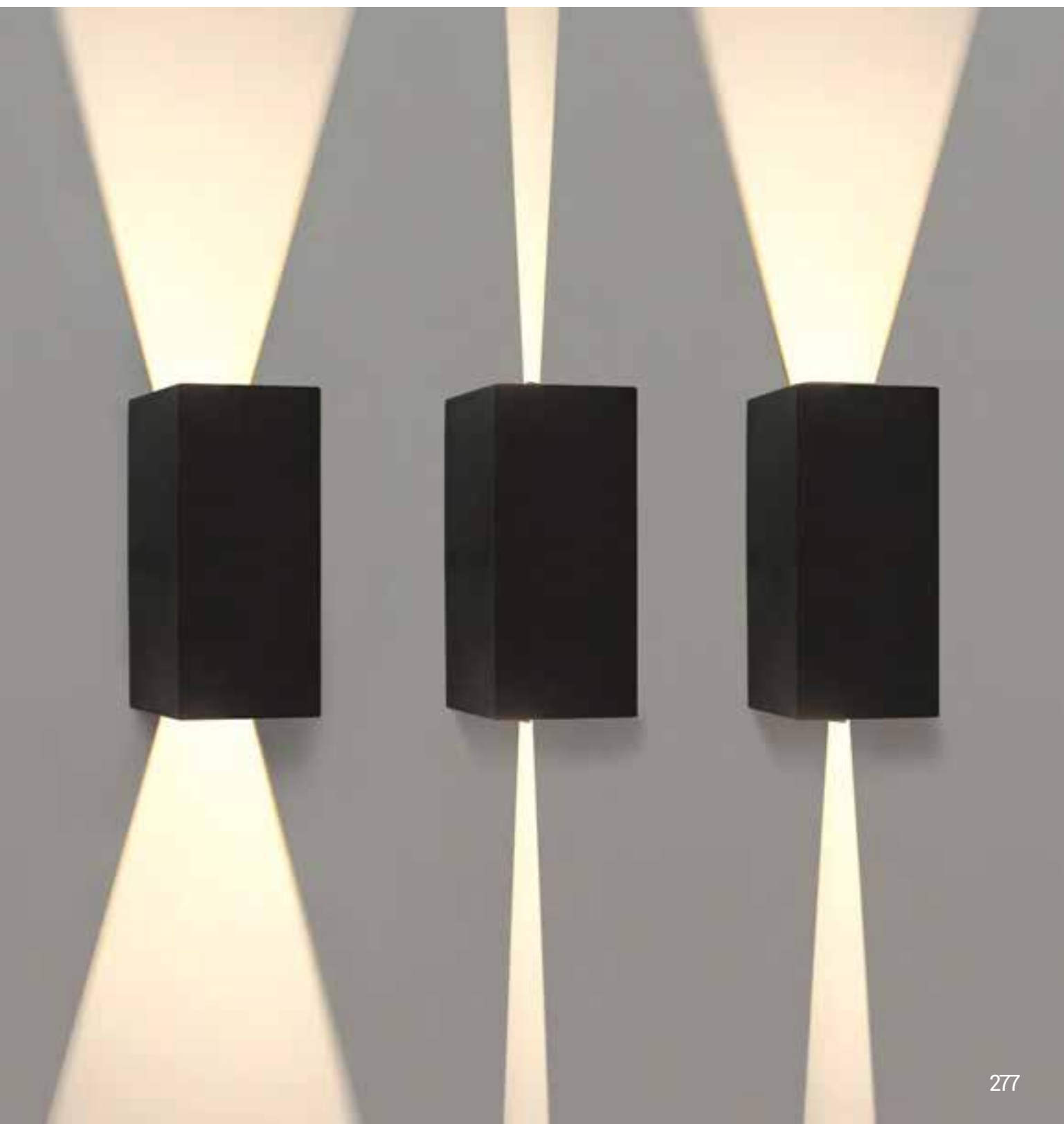



# KOPYO



**KOPYO | APLIQUE | 25W GU10 |** máx 250V~50-60Hz



AL + G

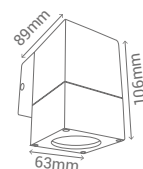

| REF    | W Máx. |      | COLOR          |
|--------|--------|------|----------------|
| 112278 | 25W    | GU10 | gris           |
| 112355 | 25W    | GU10 | gris antracita |

**KOPYO | APLIQUE | 2x25W GU10 |** máx 250V~50-60Hz

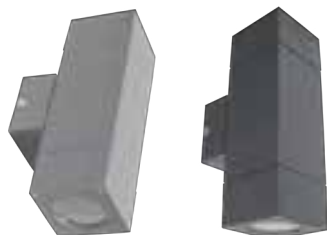

AL + G

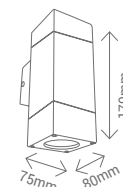

| REF    | W Máx. |      | COLOR          |
|--------|--------|------|----------------|
| 112276 | 2x25W  | GU10 | gris           |
| 112353 | 2x25W  | GU10 | gris antracita |

**KOPYO | APLIQUE | 2x25W E27 |** máx 250V~50-60Hz



AL + G

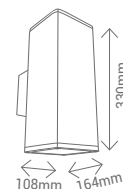

| REF    | W Máx. |     | COLOR          |
|--------|--------|-----|----------------|
| 112273 | 2x25W  | E27 | gris           |
| 112350 | 2x25W  | E27 | gris antracita |



# LOPE



LOPE | APLIQUE | 60W E27 | máx 250V~50-60Hz



AL + G

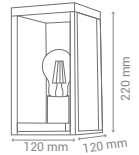

| REF    | W Máx. |     | COLOR          |
|--------|--------|-----|----------------|
| 700200 | 1X60W  | E27 | gris antracita |

LOPE | APLIQUE | 60W E27 | máx 250V~50-60Hz



AL + G

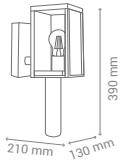

| REF    | W Máx. |     | COLOR          |
|--------|--------|-----|----------------|
| 700201 | 1x60W  | E27 | gris antracita |

LOPE | COLGANTE | 60W E27 | máx 250V~50-60Hz



AL + G

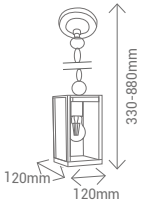

| REF    | W Máx. |     | COLOR          |
|--------|--------|-----|----------------|
| 700202 | 1x60W  | E27 | gris antracita |





COBSOIL R



COB SOIL ROUND | APLIQUE DE SUELO | COB 3W | 100-240V~50-60Hz

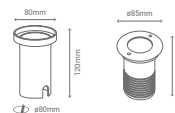

AL + G

30.000h  $\text{U}^{\text{E}}$ -5~+40°C  $\Phi$  PF 0.50  $\text{IP}$  67 25°  $\text{A}^{++}$  CRI 70

| REF    | CCT   | LM  | COLOR    |
|--------|-------|-----|----------|
| 111197 | 3000K | 300 | aluminio |
| 111325 | 4000K | 320 | aluminio |

COB SOIL ROUND | APLIQUE DE SUELO | COB 3W | 220-240V~50-60Hz

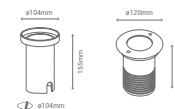

AL + G

30.000h  $\text{U}^{\text{E}}$ -5~+40°C  $\Phi$  PF 0.50  $\text{IP}$  67 13°  $\text{A}^{+}$  CRI 80

| REF    | CCT   | LM   | COLOR    |
|--------|-------|------|----------|
| 111058 | 3000K | 1320 | aluminio |



THIN +  
PEG +  
YUKA +





THIN+ | PINCHO | SMD 3W | 100-240V~50-60Hz

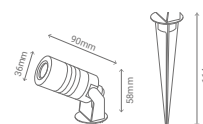

AL + G



| REF    | CCT   | LM  | COLOR |
|--------|-------|-----|-------|
| 111050 | 3000K | 130 | negro |

THIN+ | PINCHO | COB 10W | 220-240V~50-60Hz

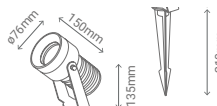

AL + G



| REF    | CCT   | LM  | COLOR |
|--------|-------|-----|-------|
| 111051 | 3000K | 910 | negro |

PEG+ | PINCHO | COB 6W | 200-240V~50-60Hz

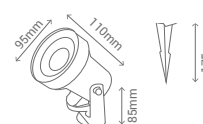

AL + G



| REF    | CCT   | LM  | COLOR |
|--------|-------|-----|-------|
| 111205 | 3000K | 550 | negro |

YUKA+ | PINCHO | 1x35W GU10 | máx. 250V~50-60Hz

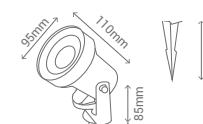

AL + G



| REF    | W Máx. | Socket | COLOR |
|--------|--------|--------|-------|
| 112308 | 1x35W  | GU10   | negro |



COBAQUA



COBAQUA | BALIZAS | COB 7W | 100-240V~50-60Hz



AL

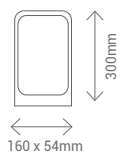

| REF    | CCT   | LM  | COLOR          |
|--------|-------|-----|----------------|
| 111140 | 3000K | 361 | gris antracita |
| 112154 | 3000K | 361 | marrón         |

COBAQUA | BALIZAS | COB 7W | 100-240V~50-60Hz



AL

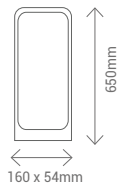

| REF    | CCT   | LM  | COLOR          |
|--------|-------|-----|----------------|
| 111141 | 3000K | 361 | gris antracita |
| 111153 | 3000K | 361 | marrón         |



R E C O R D





RECORD | APLIQUE | 1x25W E27 | máx 250V~50-60Hz



AL + G

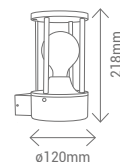

| REF    | W Máx. |     | COLOR          |
|--------|--------|-----|----------------|
| 112293 | 1x25W  | E27 | gris antracita |

RECORD | BALIZAS | 1x25W E27 | máx 250V~50-60Hz



AL + G

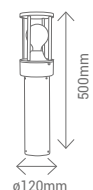

| REF    | W Máx. |     | COLOR          |
|--------|--------|-----|----------------|
| 112295 | 1x25W  | E27 | gris antracita |



# OUTDOOR



**OUTDOOR** | PLAFONES | SMD 18W | 100-240V~50-60Hz



AL + AC



| REF    | CCT   | LM   | COLOR          |
|--------|-------|------|----------------|
| 121194 | 4000K | 1500 | blanco         |
| 101194 | 4000K | 1500 | gris antracita |

**OUTDOOR** | PLAFONES | SMD 18W | 100-240V~50-60Hz

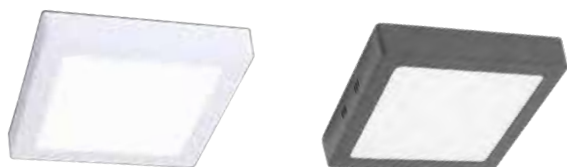

AL + AC



| REF    | CCT   | LM   | COLOR          |
|--------|-------|------|----------------|
| 120039 | 4000K | 1500 | blanco         |
| 110039 | 4000K | 1500 | gris antracita |

**OUTDOOR** | PLAFONES | SMD 30W | 100-240V~50-60Hz



AL + AC



| REF    | CCT   | LM   | COLOR          |
|--------|-------|------|----------------|
| 122055 | 4000K | 2400 | blanco         |
| 122052 | 4000K | 2400 | gris antracita |

**OUTDOOR** | PLAFONES | SMD 30W | 100-240V~50-60Hz

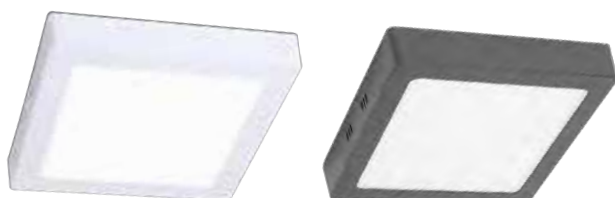

AL + AC



| REF    | CCT   | LM   | COLOR          |
|--------|-------|------|----------------|
| 122054 | 4000K | 2400 | blanco         |
| 122053 | 4000K | 2400 | gris antracita |





# R A P H A

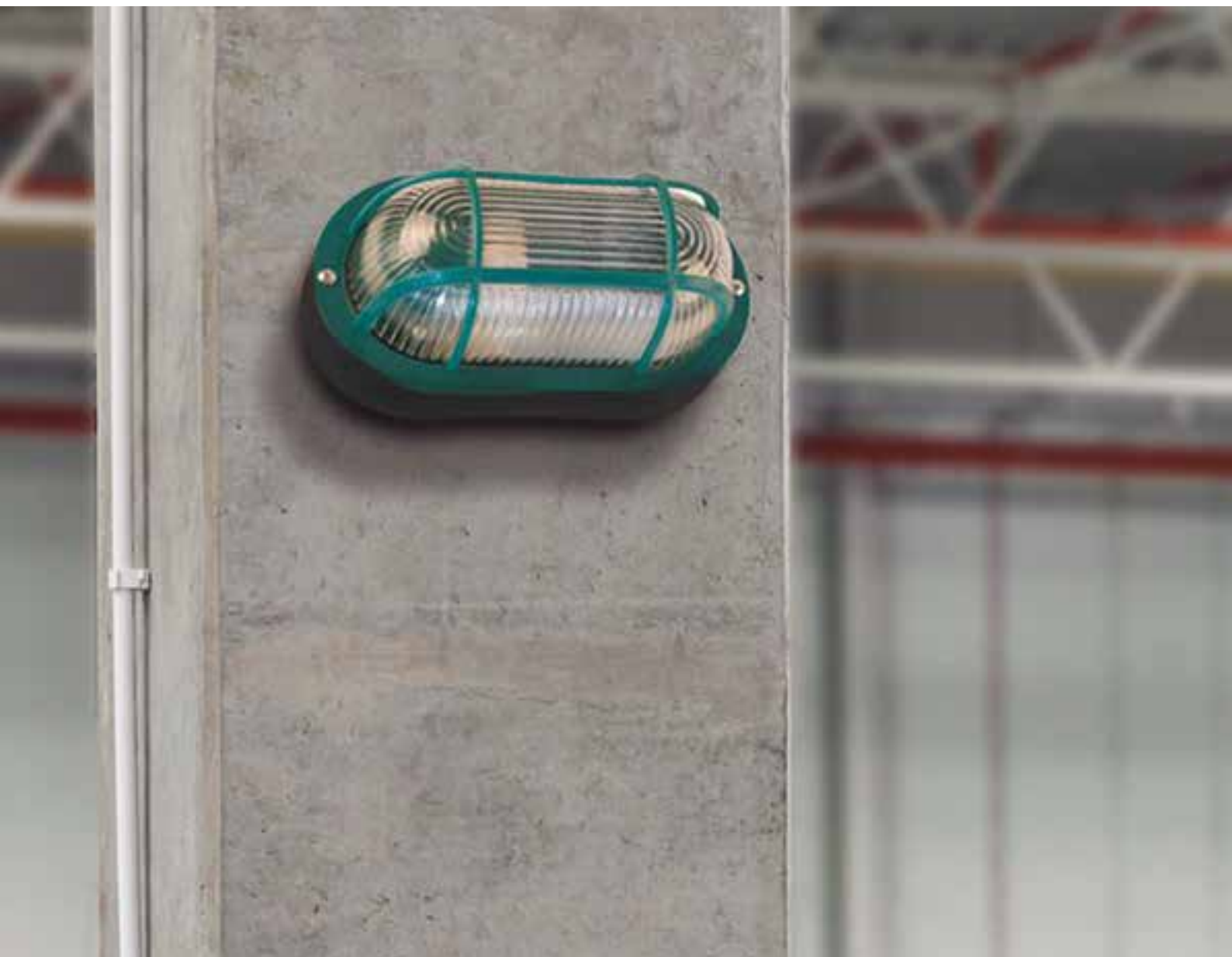

**RAPHA** | APLIQUE | 1x60W E27 | máx 250V ~50-60Hz



A + G

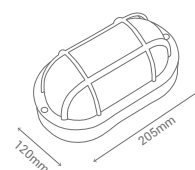

| REF    | W Máx. |     | COLOR |
|--------|--------|-----|-------|
| 101763 | 1x60   | E27 | VERDE |

# G R A S S



O U T D O O R

**GRASS** | APLIQUES | SMD 18W | 220-240V~50-60Hz

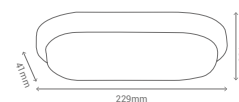

PC



| REF    | CCT   | LM   | COLOR  |
|--------|-------|------|--------|
| 100763 | 4000K | 1300 | blanco |

**GRASS** | APLIQUES | SMD 18W | 220-240V~50-60Hz

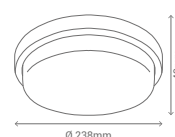

PC



| REF    | CCT   | LM   | COLOR  |
|--------|-------|------|--------|
| 101183 | 4000K | 1300 | blanco |



# CANADIAN

OUTDOOR

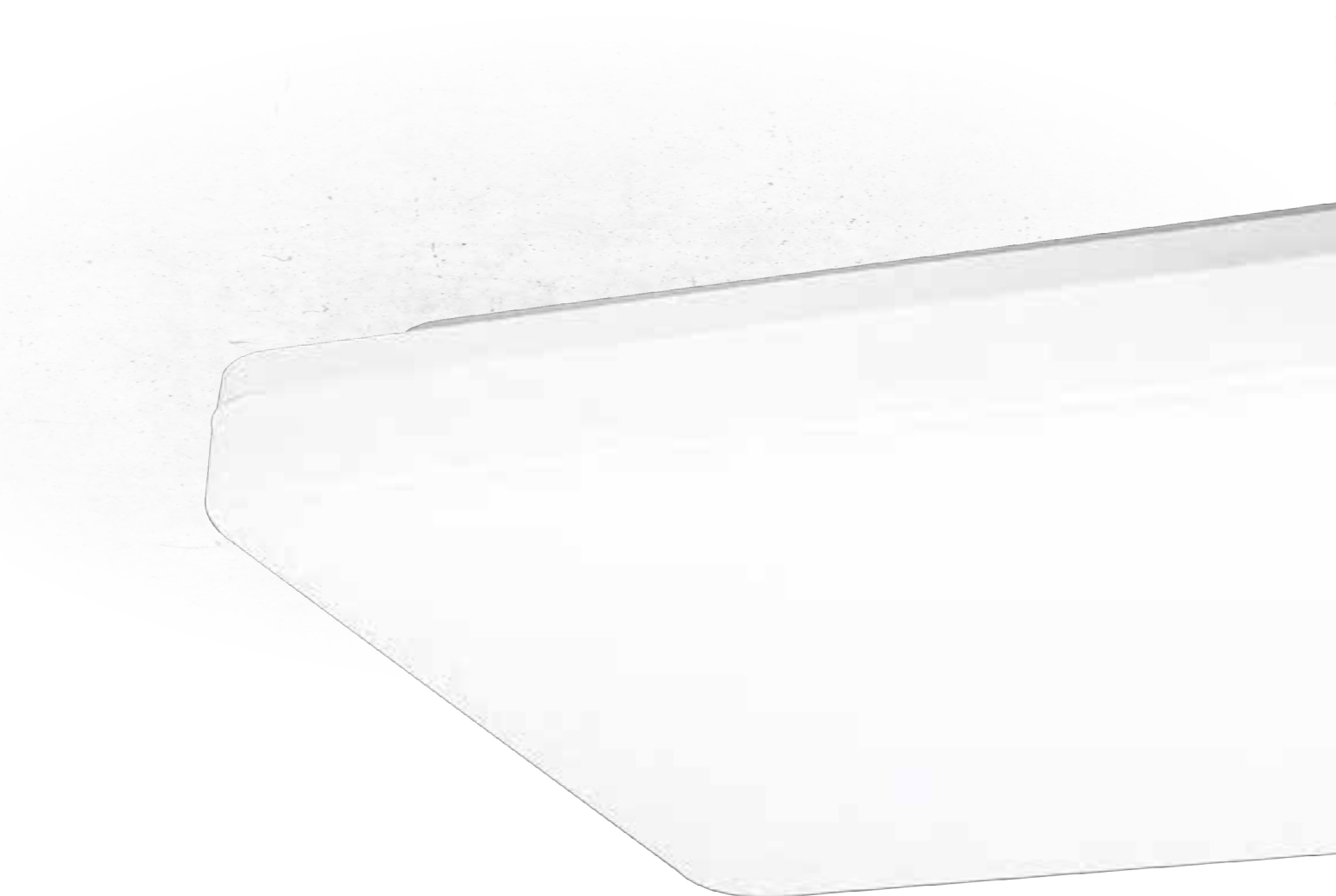

CANADIAN | PLAFÓN | SMD24W | 100-240V~50-60Hz

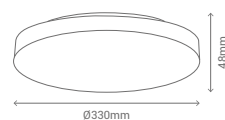

PC



| REF    | CCT   | LM   | COLOR  |
|--------|-------|------|--------|
| 100764 | 4000K | 2500 | blanco |

CANADIAN | PLAFÓN | SMD24W | 100-240V~50-60Hz

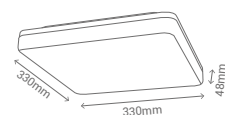

PC



| REF    | CCT   | LM   | COLOR  |
|--------|-------|------|--------|
| 100765 | 4000K | 2500 | blanco |





BUILT



**BUILT** | CAMPANAS | SMD 100W | 100-305V~50-60Hz



| REF    | CCT   | LM    | COLOR |
|--------|-------|-------|-------|
| 100757 | 4000K | 12000 | negro |

**BUILT** | CAMPANAS | SMD 150W | 100-305V~50-60Hz



| REF    | CCT   | LM    | COLOR |
|--------|-------|-------|-------|
| 101182 | 4000K | 20050 | negro |

**BUILT** | ÓPTICA | 50°



| REF   | Lmm  | COLOR |
|-------|------|-------|
| 50624 | ø300 | ø300  |

**BUILT** | SENSOR |



| REF   | COLOR |
|-------|-------|
| 50625 | negro |

**BUILT** | FIJACIÓN |



| REF   | COLOR |
|-------|-------|
| 50626 | negro |

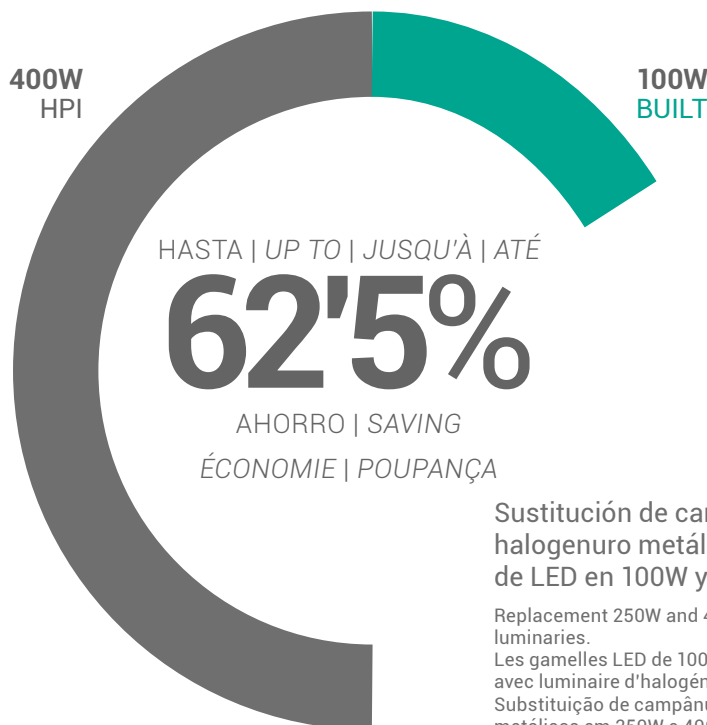

Sustitución de campanas industriales con lámpara de halogenuro metálico en 250W y 400W por campanas de LED en 100W y 150W.

Replacement 250W and 400W HPI luminaries by 100W and 250W LED luminaries.

Les gamelles LED de 100W et 250W remplacent les gamelles industrielles avec luminaire d'halogénure métallique de 250W et 400W.

Substituição de campânulas industriais com lâmpada de halogenetos metálicos em 250W e 400W pelos LEDs em 100W e 150W.





# MASINI



MASINI | PROYECTOR | SMD 10W | 220-240V~50-60Hz

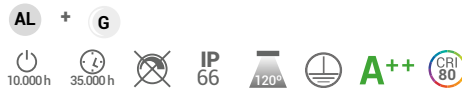
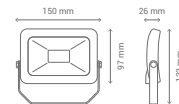

| REF    | CCT   | LM  | COLOR  |
|--------|-------|-----|--------|
| 112323 | 3000K | 760 | blanco |
| 112415 | 4000K | 800 | blanco |
| 112416 | 4000K | 800 | negro  |

MASINI | PROYECTOR | SMD 30W | 220-240V~50-60Hz

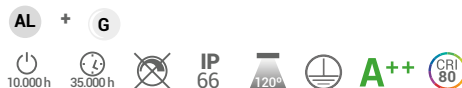
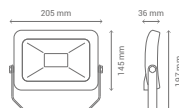

| REF    | CCT   | LM   | COLOR  |
|--------|-------|------|--------|
| 112324 | 3000K | 2280 | blanco |
| 112419 | 4000K | 2400 | blanco |
| 112420 | 4000K | 2400 | negro  |

MASINI | PROYECTOR | SMD 50W | 220-240V~50-60Hz

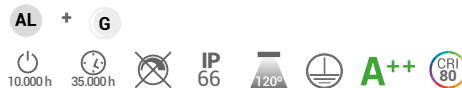
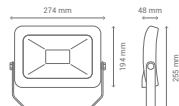

| REF    | CCT   | LM   | COLOR  |
|--------|-------|------|--------|
| 112421 | 4000K | 4000 | blanco |
| 112422 | 4000K | 4000 | negro  |

MASINI | PROYECTOR | SMD 10W | 220-240V~50-60Hz

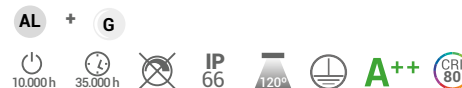
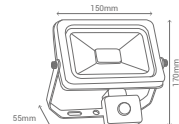

| REF    | CCT   | LM  | COLOR  |
|--------|-------|-----|--------|
| 112320 | 4000K | 800 | blanco |
| 112322 | 4000K | 800 | negro  |

MASINI | PROYECTOR | SMD 30W | 220-240V~50-60Hz

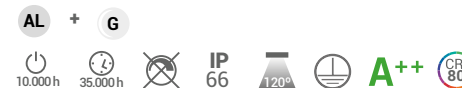

| REF    | CCT   | LM   | COLOR  |
|--------|-------|------|--------|
| 112321 | 4000K | 2280 | blanco |
| 112325 | 4000K | 2280 | negro  |

MASINI | PROYECTOR | SMD 50W | 220-240V~50-60Hz

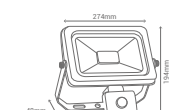

| REF    | CCT   | LM   | COLOR  |
|--------|-------|------|--------|
| 112327 | 4000K | 4000 | blanco |
| 112329 | 4000K | 4000 | negro  |

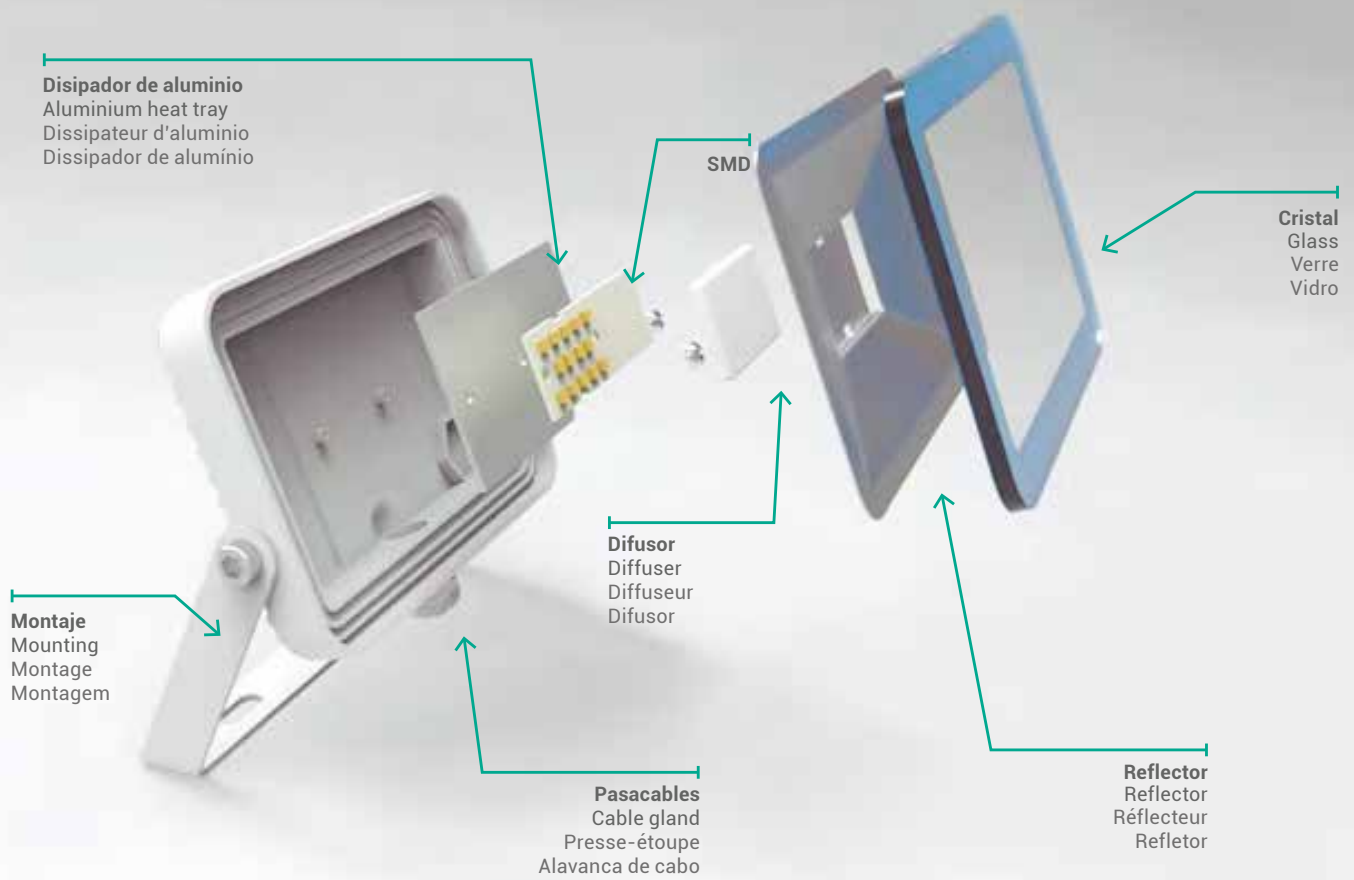







S O L A R



Proximity Sensor Light





# KIPPER



**KIPPER** | APLIQUE + PINCHO | LED SMD 5W | 2.7V 1200mAh

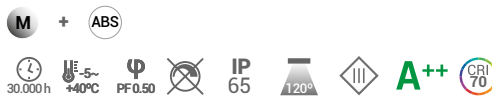
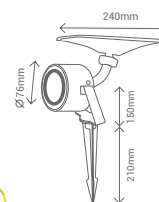

| REF    | CCT   | LM    | COLOR |
|--------|-------|-------|-------|
| 112432 | 4000k | 210lm | Black |



**KIPPER** | EMPOTRBALE SUELO | LED SMD 1,5W | 3.2V 500mAh

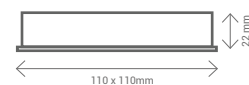

| REF    | CCT   | LM    | COLOR |
|--------|-------|-------|-------|
| 200597 | 6000k | 120lm | negro |

# BIRD





**BIRD** | APLIQUE + PINCHO | LED SMD 10W | 3.7V 1200mAh

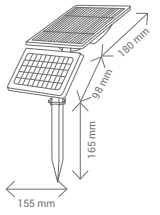

| REF    | CCT   | LM  | COLOR |
|--------|-------|-----|-------|
| 200582 | 6000k | 300 | negro |



# SUNY





SUNY | APLIQUE | LED SMD 6W | 3.7V 1200mAh

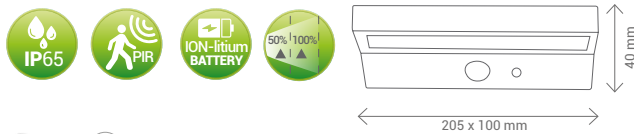

| REF    | CCT   | LM            | COLOR |
|--------|-------|---------------|-------|
| 112413 | 4000K | 75 - 400- 600 | negro |



# NEKO





NEKO | APLIQUE | LED SMD 3W | 3.7V 800mAh

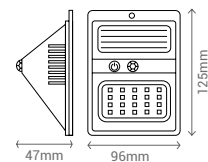

| REF    | CCT   | LM  | COLOR |
|--------|-------|-----|-------|
| 112262 | 6000K | 230 | negro |



**E L E C T R O N I C S**



SOLUTION

DRIVER MEAN WELL | IP67 24V | 100-240V ~50-60hz

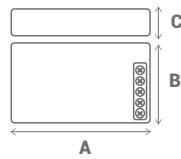

| REF : | W    | input       | output      | Size (mm) |     |    |
|-------|------|-------------|-------------|-----------|-----|----|
|       |      |             |             | A         | B   | C  |
| 24125 | 25W  | 100-240V AC | 24V DC 1,1A | 99        | 82  | 35 |
| 24135 | 35W  | 100-240V AC | 24V DC 1,5A | 99        | 97  | 36 |
| 24175 | 75W  | 100-240V AC | 24V DC 3,2A | 159       | 97  | 38 |
| 24010 | 100W | 100-240V AC | 24V DC 4,5A | 159       | 97  | 38 |
| 24150 | 150W | 100-240V AC | 24V DC 6,5A | 200       | 97  | 38 |
| 24200 | 200W | 100-240V AC | 24V DC 8,4A | 215       | 115 | 30 |
| 24250 | 250W | 100-240V AC | 24V DC 10A  | 215       | 115 | 30 |

DRIVER MEAN WELL | IP67 24V | 100-240V ~50-60hz

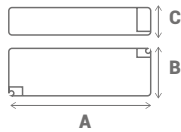

| REF : | W    | input       | output      | Size (mm) |    |    |
|-------|------|-------------|-------------|-----------|----|----|
|       |      |             |             | A         | B  | C  |
| 24020 | 25W  | 100-240V AC | 24V DC 1,1A | 118       | 35 | 26 |
| 24035 | 35W  | 100-240V AC | 24V DC 1,5A | 148       | 40 | 30 |
| 24060 | 60W  | 100-240V AC | 24V DC 3,2A | 163       | 43 | 32 |
| 24100 | 100W | 100-240V AC | 24V DC 4,5A | 190       | 52 | 37 |
| 24350 | 150W | 100-240V AC | 24V DC 4,5A | 191       | 63 | 38 |

DRIVER SULION | IP20 24V | 100-240V ~50-60hz

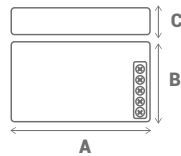

| REF : | W    | input       | output      | Size (mm) |     |    |
|-------|------|-------------|-------------|-----------|-----|----|
|       |      |             |             | A         | B   | C  |
| 24730 | 25W  | 100-240V AC | 24V DC 1,1A | 99        | 82  | 35 |
| 24740 | 40W  | 100-240V AC | 24V DC 1,5A | 99        | 97  | 36 |
| 24780 | 80W  | 100-240V AC | 24V DC 3,2A | 159       | 97  | 38 |
| 24710 | 100W | 100-240V AC | 24V DC 4,5A | 159       | 97  | 38 |
| 24715 | 150W | 100-240V AC | 24V DC 6,5A | 200       | 97  | 38 |
| 24720 | 200W | 100-240V AC | 24V DC 8,4A | 215       | 115 | 30 |
| 24725 | 250W | 100-240V AC | 24V DC 10A  | 215       | 115 | 30 |

DRIVER SULION | IP67 24V | 100-240V ~50-60hz

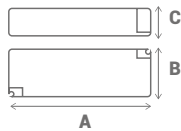

| REF : | W    | input       | output      | Size (mm) |    |    |
|-------|------|-------------|-------------|-----------|----|----|
|       |      |             |             | A         | B  | C  |
| 24630 | 25W  | 100-240V AC | 24V DC 1,1A | 118       | 35 | 26 |
| 24640 | 40W  | 100-240V AC | 24V DC 1,5A | 148       | 40 | 30 |
| 24680 | 80W  | 100-240V AC | 24V DC 3,2A | 163       | 43 | 32 |
| 24610 | 100W | 100-240V AC | 24V DC 4,5A | 190       | 52 | 37 |
| 24615 | 150W | 100-240V AC | 24V DC 6,5A | 191       | 63 | 38 |
| 24620 | 200W | 100-240V AC | 24V DC 8,4A | 215       | 74 | 40 |
| 24625 | 250W | 100-240V AC | 24V DC 10A  | 215       | 74 | 40 |

DRIVER | STRIPLED / PENN | TRIAC | 100-240V ~50-60Hz

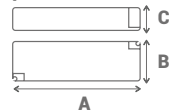

| REF : | W   | input       | output      | Size (mm) |    |    |
|-------|-----|-------------|-------------|-----------|----|----|
|       |     |             |             | A         | B  | C  |
| 24860 | 60W | 100-240V AC | 24V DC 3,2A | 175       | 60 | 25 |

DRIVER | STRIPLED / PENN | TRIAC | 200-240V ~50-60Hz

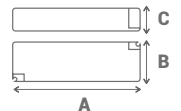

| REF : | W    | input       | output      | Size (mm) |    |    |
|-------|------|-------------|-------------|-----------|----|----|
|       |      |             |             | A         | B  | C  |
| 24800 | 100W | 200-240V AC | 24V DC 4,5A | 200       | 65 | 40 |

DRIVER | STRIPLED / PENN | IoT | 220-240V ~50-60Hz

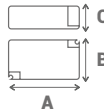

| REF :  | W    | input       | output     | Size (mm) |    |    |
|--------|------|-------------|------------|-----------|----|----|
|        |      |             |            | A         | B  | C  |
| 500334 | 384W | 220-240V AC | 24V DC 16A | 149       | 39 | 22 |

DIMER | STRIP LED | MONOCOLOR | 100-240V ~50-60Hz

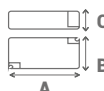

| REF : | input    | output           | Size (mm) |    |    |
|-------|----------|------------------|-----------|----|----|
|       |          |                  | A         | B  | C  |
| 80633 | 12/24VDC | 12V48W / 24V 96W | 20        | 20 | 20 |



CONTROLADOR | STRIP LED | RGB | 100-240V ~50-60Hz

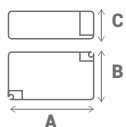

| REF : | input  | output    | Size (mm) |    |    |
|-------|--------|-----------|-----------|----|----|
|       | A      | B         | C         |    |    |
| 80600 | 12V DC | 12V DC 2A | 60        | 25 | 20 |

CONTROLADOR | STRIP LED | RGB | 100-240V ~50-60Hz

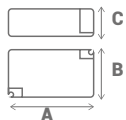

| REF : | input    | output              | Size (mm) |    |    |
|-------|----------|---------------------|-----------|----|----|
|       | A        | B                   | C         |    |    |
| 50423 | 12/24VDC | 12V 216W / 24V 432W | 60        | 25 | 20 |

frecuencia abierta / free frequency / fréquence ouverte / frequência aberta

CONTROLADOR | STRIP LED | RGB | 100-240V ~50-60Hz

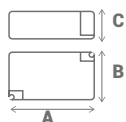

| REF : | input    | output              | Size (mm) |    |    |
|-------|----------|---------------------|-----------|----|----|
|       | A        | B                   | C         |    |    |
| 50437 | 12/24VDC | 12V 216W / 24V 432W | 50        | 25 | 20 |

emparejado / paired up / couplé / emparelhado

CONTROLADOR | STRIP LED | 100-240V ~50-60Hz

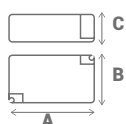

| REF : | input    | output              | Size (mm) |    |    |
|-------|----------|---------------------|-----------|----|----|
|       | A        | B                   | C         |    |    |
| 50424 | 12/24VDC | 12V 216W / 24V 432W | 50        | 25 | 20 |

frecuencia abierta / free frequency / fréquence ouverte / frequência aberta

CONTROLADOR | STRIP LED | 100-240V ~50-60Hz

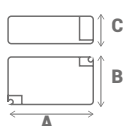

| REF : | input    | output              | Size (mm) |    |    |
|-------|----------|---------------------|-----------|----|----|
|       | A        | B                   | C         |    |    |
| 50436 | 12/24VDC | 12V 216W / 24V 432W | 50        | 25 | 20 |

emparejado / paired up / couplé / emparelhado

AMPLIFICADOR | STRIP LED | RGB | 100-240V ~50-60Hz

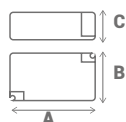

| REF : | input    | output              | Size (mm) |    |    |
|-------|----------|---------------------|-----------|----|----|
|       | A        | B                   | C         |    |    |
| 50426 | 12/24VDC | 12V 144W / 24V 288W | 50        | 25 | 20 |

emparejado / paired up / couplé / emparelhado

CONTROLADOR | STRIP LED | RGB+W | 100-240V ~50-60Hz

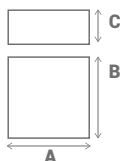

| REF : | input    | output              |
|-------|----------|---------------------|
| 50441 | 12/24VDC | 12V 192W / 24V 384W |

Size (mm)

| A  | B  | C  |
|----|----|----|
| 60 | 60 | 45 |

CONTROLADOR | STRIP LED | RGB+W | 100-240V ~50-60Hz

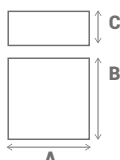

| REF : | input    | output              |
|-------|----------|---------------------|
| 50442 | 12/24VDC | 12V 144W / 24V 288W |

Size (mm)

| A  | B  | C  |
|----|----|----|
| 60 | 60 | 45 |

emparejado / paired up / couplé / emparelhado

DRIVER | DOTFIX | 3W | 100-240V ~50-60Hz

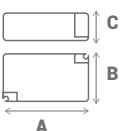

| REF : | W  | input       | output       |
|-------|----|-------------|--------------|
| 81536 | 3W | 100-240V AC | 24V DC 0.08A |

Size (mm)

| A  | B  | C  |
|----|----|----|
| 35 | 25 | 20 |

DRIVER | DOTFIX x3 | 3W | 100-240V ~50-60Hz

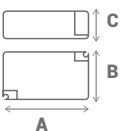

| REF : | W  | input       | output       |
|-------|----|-------------|--------------|
| 50618 | 3W | 100-240V AC | 24V DC 0.08A |

Size (mm)

| A  | B  | C  |
|----|----|----|
| 35 | 25 | 20 |

CONECTOR | DOTFIX | x3 |

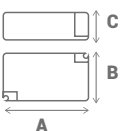

| REF   | sec.ø | Lmm |
|-------|-------|-----|
| 50607 | -     | 30  |

DRIVER | VISIO | 12W | 100-277V ~50-60Hz

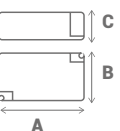

| REF : | W   | input       | output         |
|-------|-----|-------------|----------------|
| 25153 | 12W | 100-277V AC | 21-42V DC 0,3A |

Size (mm)

| A  | B  | C  |
|----|----|----|
| 90 | 40 | 20 |

DRIVER | VISIO | 1-11W TUYA | 100-240V ~50-60Hz

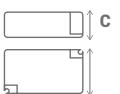

| REF : | W     | input       | output       |
|-------|-------|-------------|--------------|
| 25152 | 1-11W | 100-240V AC | 21-42V DC 1A |

Size (mm)

| A  | B  | C  |
|----|----|----|
| 90 | 40 | 30 |



**DRIVER | PLATE | SIN FLICKER | 175-265V ~50-60Hz**

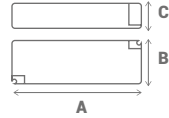

| REF : | W   | input       | output       |
|-------|-----|-------------|--------------|
| 81570 | 40W | 175-265V AC | 27-42V DC 1A |

Size (mm)

| A   | B  | C  |
|-----|----|----|
| 140 | 40 | 30 |

**DRIVER | PLATE | TRIAC | 200-240V ~50-60Hz**

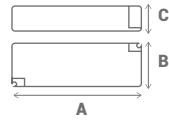

| REF : | W   | input       | output       |
|-------|-----|-------------|--------------|
| 80621 | 60W | 200-240V AC | 24V DC 0,42A |

Size (mm)

| A   | B  | C  |
|-----|----|----|
| 175 | 60 | 25 |

**DRIVER | PLATE | 1-10V | 200-240V ~50-60Hz**

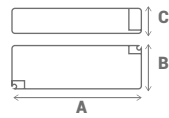

| REF : | W   | input       | output       |
|-------|-----|-------------|--------------|
| 80536 | 60W | 200-240V AC | 24V DC 0,42A |

Size (mm)

| A   | B  | C  |
|-----|----|----|
| 140 | 40 | 30 |





# F A N

Gran tamaño  
Grande dimension  
Tamanho grande



## ¿QUE ES UN MOTOR AC o DC?

Existen dos tipos de motores eléctricos: AC (Corriente Alterna), que es la corriente eléctrica que cambia de sentido, y DC (Corriente Directa), que es la corriente eléctrica que sólo fluye en una dirección. Los motores AC funcionan al conectarse directamente a una fuente de alimentación. Con los motores DC de corriente directa, la corriente alterna (AC) se conecta a un transformador incluido en el motor del ventilador, que convierte la energía en DC. El efecto es que disminuye la cantidad de energía usando la corriente directa en lugar de la corriente alterna. Para crear entonces la fuerza necesaria para rotar el rotor del motor, el motor DC usa un sistema de imanes con polaridad opuesta.

## QU'EST-CE QU'UN MOTEUR AC OU DC?

Il existe deux types de moteurs électriques: le courant alternatif (CA), qui correspond au courant électrique qui change de direction, et le courant continu (CC), qui correspond au courant électrique circulant dans un seul sens. Moteurs AC directement à une source d'alimentation. Avec les moteurs CC à courant continu, le courant alternatif (CA) est connecté à un transformateur inclus dans le moteur du ventilateur, qui convertit le courant en CC. L'effet est qu'il diminue la quantité d'énergie en utilisant le courant continu à la place du courant alternatif. Pour créer ensuite la force nécessaire à la rotation du moteur, le moteur à courant continu utilise un système magnétique de polarité opposée.

## WHAT IS AN AC OR DC MOTOR?

There are two types of electric motors: AC (Alternating Current), which is the electric current that changes direction, and DC (Direct Current), which is the electric current that only flows in one direction. AC motors directly to a power source. With direct current DC motors, alternating current (AC) is connected to a transformer included in the fan motor, which converts the power to DC. The effect is that it decreases the amount of energy using the direct current at the place of the alternating current. To then create the force needed to rotate the motor, the DC motor uses a magnet system with opposite polarity.

## O QUE É UM MOTOR AC OU DC?

Existem dois tipos de motores elétricos: AC (Corrente Alternada), que é a corrente elétrica que muda de direção, e DC (Corrente Contínua), que é a corrente elétrica que flui apenas em uma direção. Os motores CA funcionam ligando-se diretamente a uma fonte de energia. Com os motores DC de corrente contínua, a corrente alternada (AC) é conectada a um transformador incluído no motor da ventoinha, que transforma a energia em DC. O efeito é que diminui a quantidade de energia consumida, fazendo uso da corrente contínua em vez de corrente alternada. Para criar então a força necessária para girar o rotor do motor, o motor DC usa um sistema magnético com polaridade oposta.

### AC MOTOR



**3-4 Velocidades**  
3-4 Speed  
3-4 Vitesses  
3-4 Velocidades



**Más baratos**  
Cheaper  
Moins cher  
Mais baratos

### DC MOTOR



**5-6 Velocidades**  
5-6 Speed  
5-6 Vitesses  
5-6 Velocidades



**Consumo < 70%**  
Consumption < 70%  
Consommation < 70%  
Consumo < 70%



**Diseño compacto y ligero**  
Compact and light design  
Design compact et plus léger  
Desenho compacto e mais leve



**Silenciosos**  
Soundless  
Silencieux  
Silencioso



# MODO VERANO / INVIERNO

## ¿SUTITUYE AL AIRE ACONDICIONADO?

Does Summer/winter mode replace air conditioning?

Mode été/hiver, remplace-t-il la climatisation?

Modo verão/inverno, substitui o ar condicionado?



## Verano

Summer / Été / Verão



### ¿PORQUÉ USAR UN VENTILADOR DE TECHO EN VERANO?

1. El aire en movimiento genera una sensación térmica de hasta 5°C menos en la estancia.
2. Un ventilador de techo DC consume un 70% menos que un ventilador AC, llegando a reducir hasta en un 50% el gasto de un aparato de aire acondicionado.
3. La combinación del ventilador con el uso de un aire acondicionado disminuye considerablemente el consumo eléctrico de este.

### POURQUOI UTILISER UN VENTILATEUR DE PLAFOND EN ÉTÉ?

1. L'air en mouvement génère une sensation thermique de jusqu'à 5°C de moins dans une salle.
2. Un ventilateur de plafond DC consomme environ 70% de moins qu'un ventilateur AC et permet jusqu'à 50% de réduction du coût d'un appareil d'air conditionné.
3. L'utilisation d'un ventilateur combiné avec l'air conditionné diminue considérablement le niveau de consommation électrique de ce dernier.

### WHY USING YOUR CEILING FAN IN SUMMER?

1. Air circulation makes a room feel up to 5 degrees cooler.
2. A DC ceiling fan consumes 70% less energy than an AC fan, reducing up to 50% the cost of an air conditioning unit.
3. The combined use of a ceiling fan and an air conditioning unit reduces electric consumption.

### PORQUÉ USAR UMA VENTONINHA DE TETO EM VERÃO?

1. O ar em movimento gera uma sensação térmica de até 5°C menos na estância.
2. Uma ventoinha de teto DC consome um 70% menos que uma ventoinha AC, reduzindo até um 50% o custo de um aparelho de ar condicionado.
3. A combinação de ventoinha com o ar condicionado reduz consideravelmente o consumo elétrico deste último.



## Invierno

Winter / Hiver / Inverno



### ¿PORQUÉ USAR UN VENTILADOR DE TECHO EN INVIERNO?

1. Forzar la distribución de aire caliente evita la estratificación del mismo en zonas altas mejorando la sensación de confort.
2. Gracias al menor consumo de los ventiladores DC frente a los AC, en modo invierno se puede reducir el gasto de calefacción hasta en 30%.
3. A diferencia de estufas y radiadores, el ventilador es un dispositivo que no abarca espacio hábil.

### WHY USING YOUR CEILING FAN IN WINTER?

1. Redistributing warm air prevents its stratification at the ceiling, increasing comfort.
2. Because DC ceiling fans consume less than AC fans, in winter mode, they reduce heating costs up to 30%.
3. Unlike heaters and radiators, ceiling fans do not take up floor space.

### POURQUOI UTILISER UN VENTILATEUR DE PLAFOND EN HIVER?

1. Forcer le mouvement d'air chaud évite sa stratification dans les niveaux supérieurs et augmente le niveau de confort.
2. Grâce à la consommation réduite des ventilateurs DC par rapport aux AC, le coût de chauffage peut diminuer jusqu'à 30% avec le mode hiver.
3. À différence des radiateurs, le ventilateur est un dispositif qui n'encombre pas les espaces utiles.

### PORQUÉ USAR UMA VENTONINHA DE TETO EM INVERNO?

1. Forçando a distribuição de ar quente evita-se a estratificação do mesmo em áreas altas melhorando a sensação de conforto.
2. Graças ao menor consumo das ventoinhas DC vs AC, em modo inverno, pode reduzir-se as despesas de aquecimento até um 30%.
3. A diferença das aquecedores e dos radiadores, a ventoinha é um aparelho que não abrace espaço útil.

# COMO ELEGIR SU VENTILADOR

How to choose your ceiling fan  
 Comment choisir son ventilateur  
 Como escolher a sua ventoinha

## Step 1 | Tamaño / Size / Dimensions / Tamanho

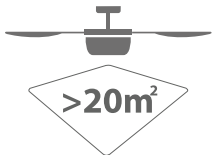

Ø1270-1820mm  
**Gran tamaño**  
 Large size  
 Grandes dimensions  
 Tamanho grande

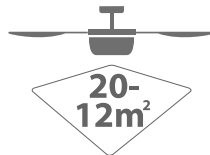

Ø1050-1220mm  
**Tamaño medio**  
 Medium size  
 Dimensions moyennes  
 Tamanho meio

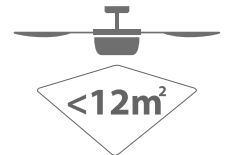

Ø760-920mm  
**Tamaño pequeño**  
 Small size  
 Petites dimensions  
 Tamanho pequeno

## Step 2 | Altura / High / Hauteur / Altura

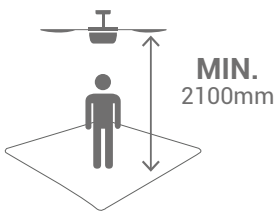

**Directo al techo**  
 Semiflush  
 À ras de plafond  
 Direto ao teto



**A dos alturasn modificables**  
 In two heights mount  
 Deux hauteurs réglable  
 Em duas alturas ajustável



**Techos inclinados**  
 Slope ceiling  
 Plafond incliné  
 Tetos inclinados

## Step 3 | Fuente de luz / Light source / Source de lumière / Fonte da luz



## Step 4 | Tipo de motor / Motor type / Type de moteur / Tipo de motor

### AC MOTOR

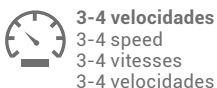

3-4 velocidades  
 3-4 speed  
 3-4 vitesses  
 3-4 velocidades



**Más baratos**  
 Cheaper  
 Moins cher  
 Mais baratos

### DC MOTOR



5-6 velocidades  
 5-6 speed  
 5-6 vitesses  
 5-6 velocidades



**consumo < 70%**  
 consumption < 70%  
 consommation < 70%  
 consumo < 70%



**Diseño compacto y ligero**  
 Compact and light design  
 Design compact et plus léger  
 Desenho compacto e mais leve



**Silenciosos**  
 Soundless  
 Silencieux  
 Silencioso



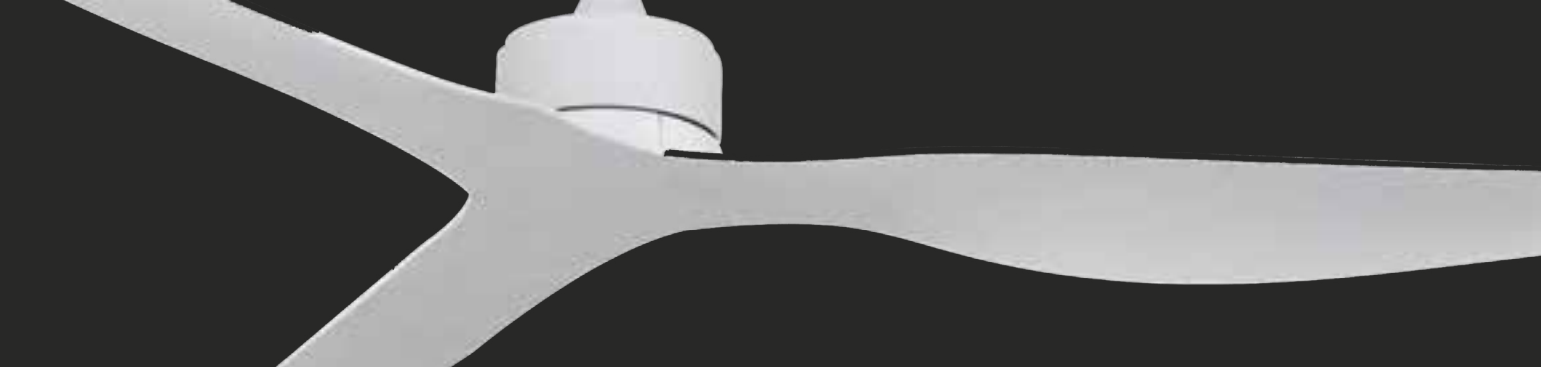

## Step 5 | Palas / Blades / Pales / Pás

Material / Material /  
Matériel / Material



Metal



MDF / Plywood



ABS



Madera / Wood /  
Bois / Madeira

Resistencia / Resistance /  
Résistance / Resistência



Aire / Air / Air / Ar



Ruido / Noise / Bruit / Ruído



## Step 6 | Mando a distancia o cadena / Remote control or chain / Télécommande ou chaînette / Comando ou corda



\* Todos los modelos que no incluyen mando permiten la instalación mando a distancia (consultar código de artículo en cada caso).

\* A remote control can be installed in all fans that don't include it (ask for remote control code in each case).

\* Le contrôle télécommandé peut être installé s'il ne vient pas d'usine (consultez la référence pour chaque ventilateur).

\* Todos os modelos que não incluem comando permitem a instalação com comando (consulte o código do artigo em cada caso)

COLLECTION | 2019



Ø 760 - 920 m m

**S M A L L   S I Z E**

Tamaño pequeño  
Petite dimension  
Tamanho pequeno

S M A L L   S I Z E



F A N

Incluye kit para instalación a ras de techo | It includes a kit for an installation flush with the ceiling | Inclus kit d'installation à ras de plafond | O kit de instalação ao nível de teto incluído

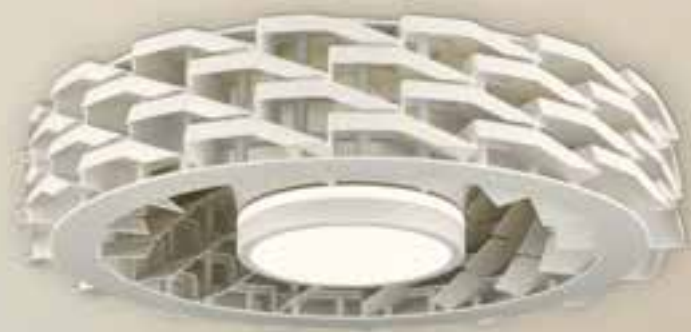

SMALL SIZE

RUBIKb | Motor DC | LED 36+15W 2400lm|220-240V ~50Hz

REF: 075319



3 MODOS DE LUZ | 3 LIGHT MODES  
3 MODES DE LUMIÈRE | 3 MODOS DE LUZ



REF 78125



REF 4954

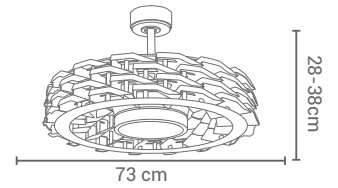

| SPEED | W    | RPM | AIRFLOW (m³/min) | dB |
|-------|------|-----|------------------|----|
| 1     | 8.2  | 90  | 40               | 29 |
| 2     | 12.6 | 122 | 70               | 33 |
| 3     | 20.1 | 154 | 80               | 38 |
| 4     | 31.4 | 184 | 100              | 42 |
| 5     | 46.6 | 218 | 120              | 47 |
| 6     | 65.7 | 249 | 130              | 52 |

RUBIKm | Motor DC | LED 36+15W 2400lm|220-240V ~50Hz

REF: 072827



3 MODOS DE LUZ | 3 LIGHT MODES  
3 MODES DE LUMIÈRE | 3 MODOS DE LUZ



REF 78125



REF 4970

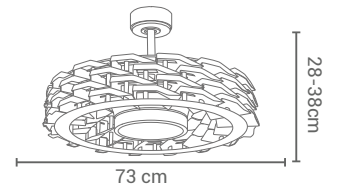

| SPEED | W    | RPM | AIRFLOW (m³/min) | dB |
|-------|------|-----|------------------|----|
| 1     | 8.2  | 90  | 40               | 29 |
| 2     | 12.6 | 122 | 70               | 33 |
| 3     | 20.1 | 154 | 80               | 38 |
| 4     | 31.4 | 184 | 100              | 42 |
| 5     | 46.6 | 218 | 120              | 47 |
| 6     | 65.7 | 249 | 130              | 52 |

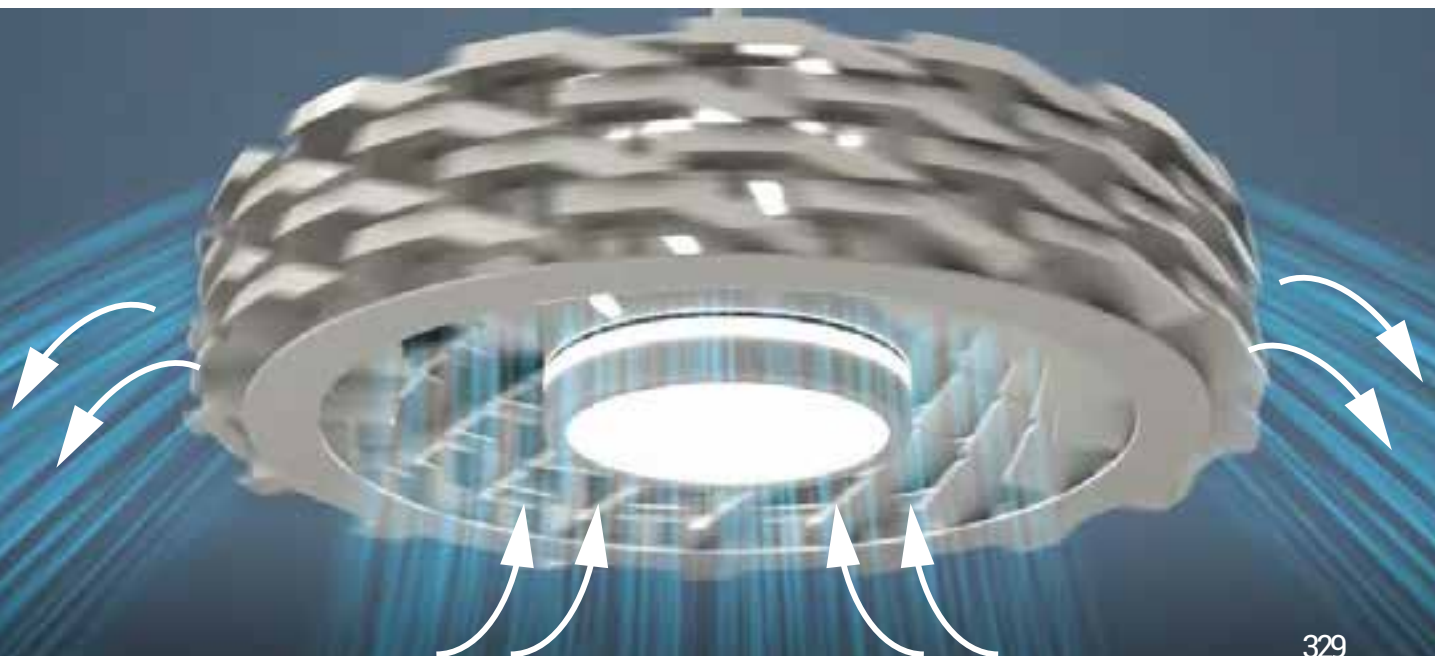



**HANNA** | Motor DC | LED 18W 1600lm | 220-240V ~50Hz

REF: 072825



REF 78128



REF 4901

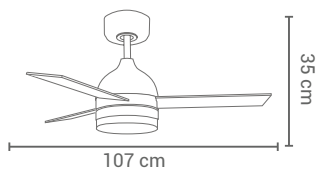

| SPEED | W  | RPM | AIRFLOW (m <sup>3</sup> /min) | dB |
|-------|----|-----|-------------------------------|----|
| 1     | 6  | 125 | 60                            | 29 |
| 2     | 8  | 151 | 72                            | 32 |
| 3     | 10 | 175 | 100                           | 39 |
| 4     | 15 | 205 | 135                           | 45 |
| 5     | 19 | 225 | 165                           | 49 |





SMALL SIZE



**HANDAIR | Motor DC | 220-240V ~50Hz**

REF: 072643

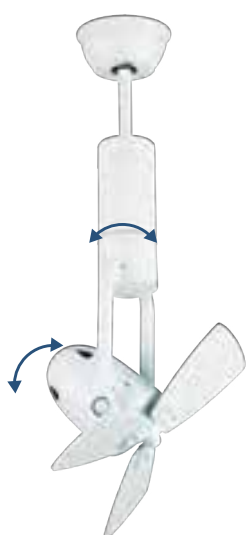

REF 78113

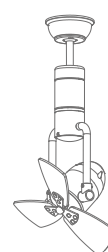

64-74 cm

38 cm



| SPEED | W   | RPM | AIRFLOW (m <sup>3</sup> /min) | dB |
|-------|-----|-----|-------------------------------|----|
| 1     | 4.5 | 650 | 48                            | 15 |
| 2     | 5.3 | 720 | 54                            | 18 |
| 3     | 6.7 | 800 | 65                            | 23 |
| 4     | 7.9 | 880 | 82                            | 26 |
| 5     | 9.7 | 950 | 130                           | 30 |

FAN



SMALL SIZE

ATUAIRE | Motor AC | LED 18W 1600lm | 220-240V~50Hz

REF: 072830

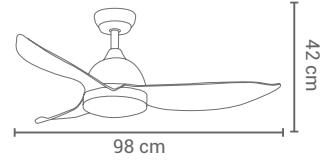

| SPEED | W  | RPM | AIRFLOW (m <sup>3</sup> /min) | dB |
|-------|----|-----|-------------------------------|----|
| 1     | 22 | 140 | 70                            | 30 |
| 2     | 40 | 185 | 115                           | 40 |
| 3     | 63 | 225 | 155                           | 45 |



REF 78127



REF 4926



**RAINBOWLED | Motor AC | LED 15W 1350lm | 220-240V ~50Hz**  
**REF: 075008**

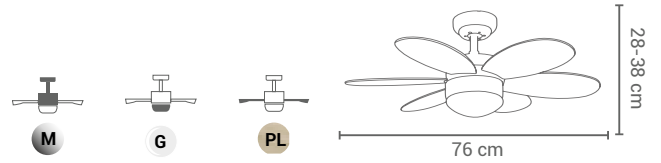

| SPEED | W  | RPM | AIRFLOW (m <sup>3</sup> /min) | dB |
|-------|----|-----|-------------------------------|----|
| 1     | 16 | 131 | 48                            | 30 |
| 2     | 27 | 187 | 67                            | 42 |
| 3     | 53 | 237 | 96                            | 46 |

**RAINBOWb | Motor AC | 1XE27 60W<sub>max</sub> | 220-240V ~50Hz**  
**REF: 075155**

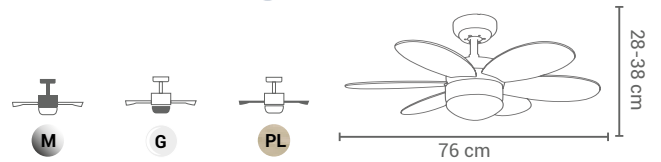

| SPEED | W  | RPM | AIRFLOW (m <sup>3</sup> /min) | dB |
|-------|----|-----|-------------------------------|----|
| 1     | 16 | 131 | 48                            | 30 |
| 2     | 27 | 187 | 67                            | 42 |
| 3     | 53 | 237 | 96                            | 46 |

**RAINBOWMulty | Motor AC | 1XE27 60W<sub>max</sub> | 220-240V ~50Hz**  
**REF: 075165**

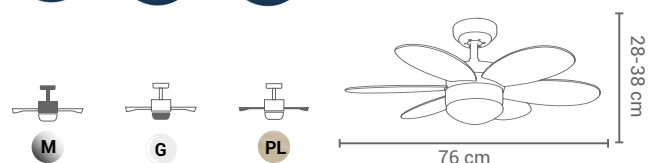

| SPEED | W  | RPM | AIRFLOW (m <sup>3</sup> /min) | dB |
|-------|----|-----|-------------------------------|----|
| 1     | 16 | 131 | 48                            | 30 |
| 2     | 27 | 187 | 67                            | 42 |
| 3     | 53 | 237 | 96                            | 46 |







SMALL SIZE

FLORA | Motor AC | 3XE27 40W<sub>max</sub> | 220-240V ~50Hz  
REF: 075262

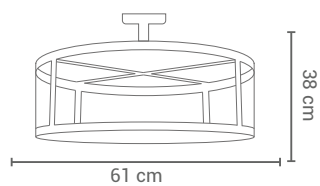

| SPEED | W   | RPM | AIRFLOW (m <sup>3</sup> /min) | dB |
|-------|-----|-----|-------------------------------|----|
| 1     | 7.7 | 254 | 34                            | 38 |
| 2     | 12  | 290 | 40                            | 41 |
| 3     | 54  | 330 | 45                            | 45 |



REF 78100

COLLECTION | 2019

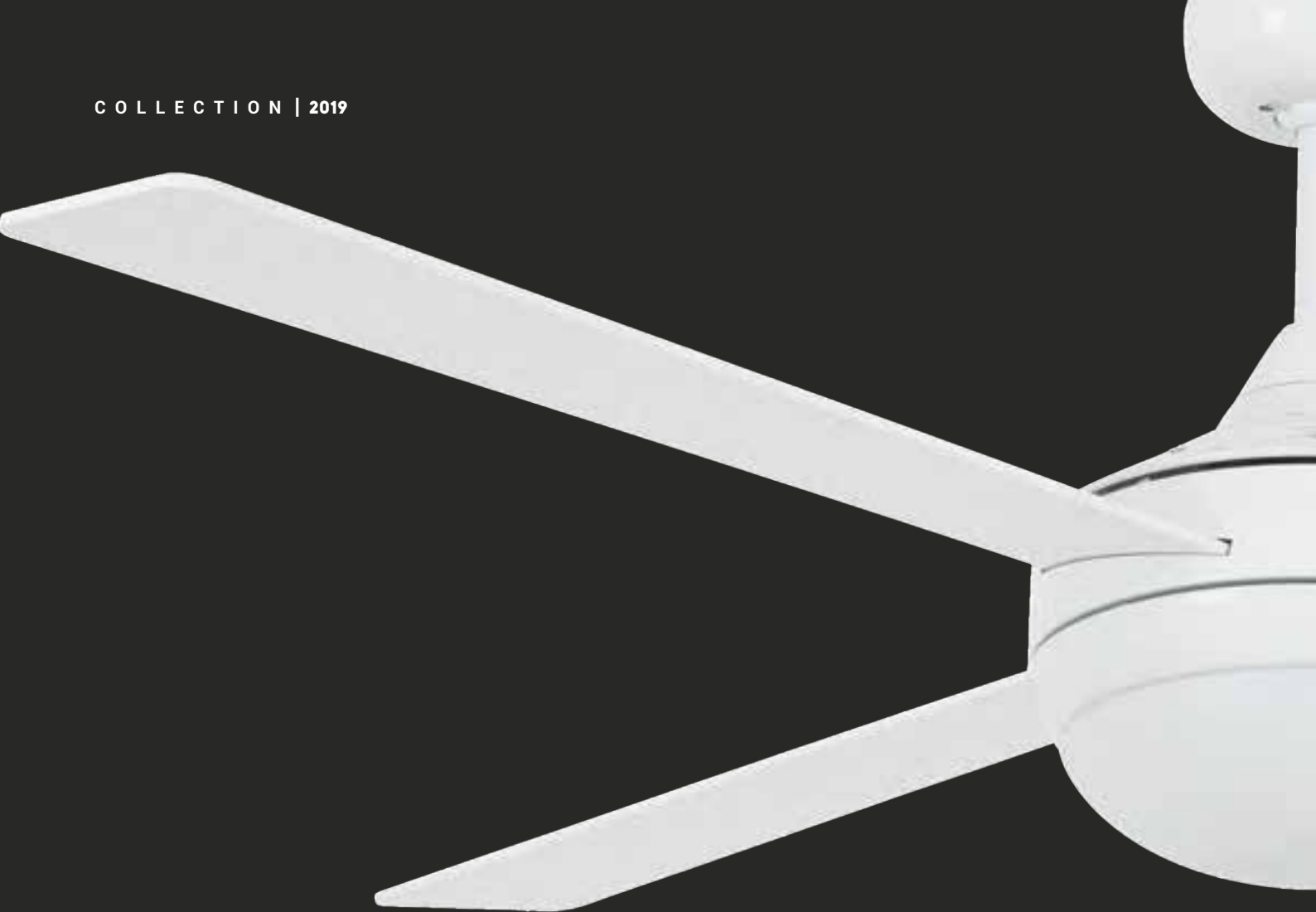

Ø 1050 - 1220 m m

MEDIUM SIZE

Tamaño medio

Dimension moyenne

Tamanho meio

MEDIUM SIZE

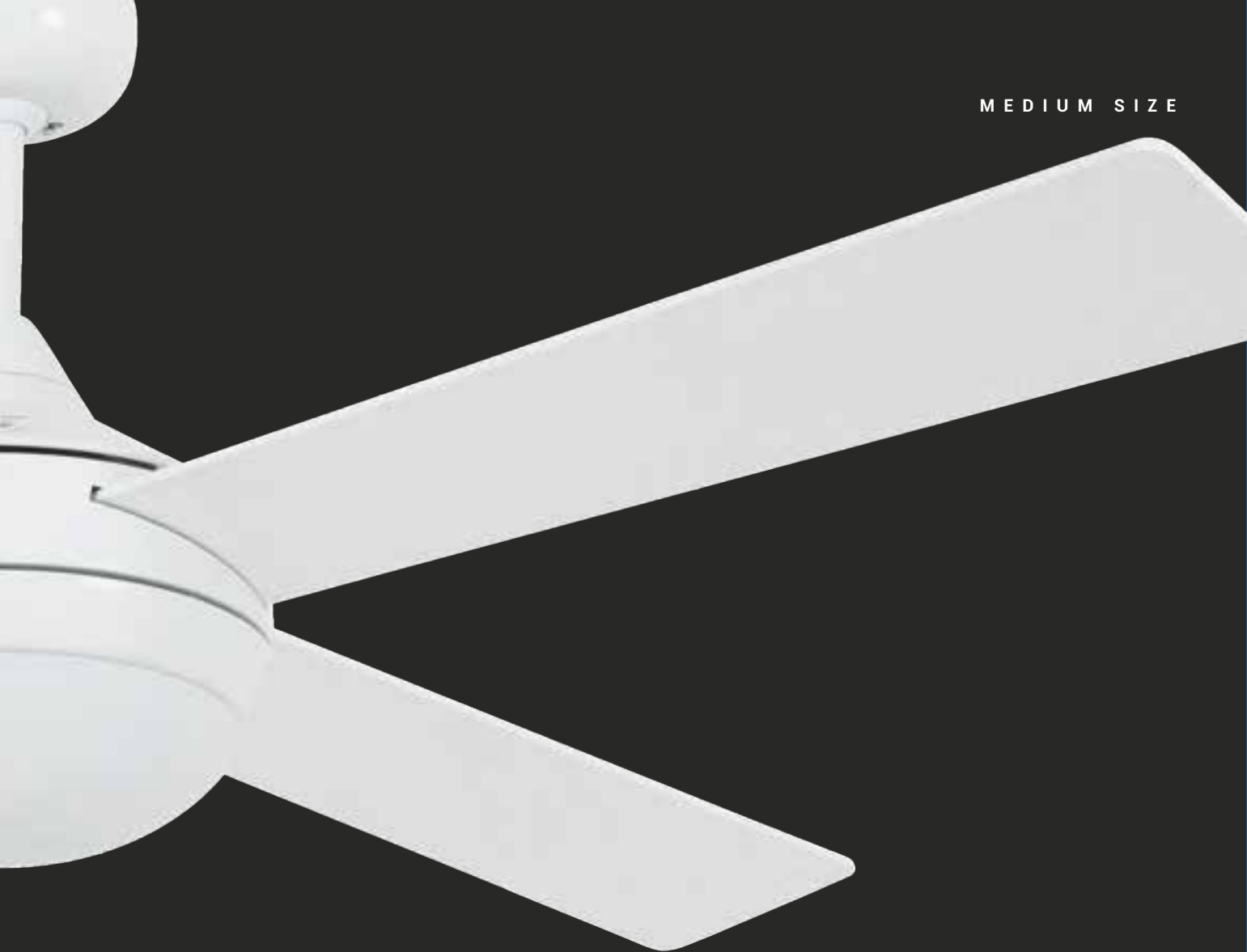

FAN



MEDIUM SIZE

CIRROS | Motor DC | LED 18W 1500lm | 220-240V ~50Hz

REF: 072824



REF 78128

REF 4944

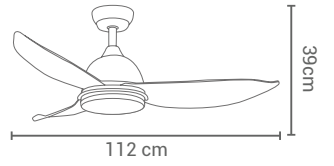

| SPEED | W  | RPM | AIRFLOW (m <sup>3</sup> /min) | dB |
|-------|----|-----|-------------------------------|----|
| 1     | 6  | 125 | 60                            | 25 |
| 2     | 8  | 151 | 72                            | 29 |
| 3     | 10 | 175 | 100                           | 35 |
| 4     | 15 | 205 | 135                           | 39 |
| 5     | 19 | 225 | 165                           | 43 |





**NEWTON | Motor AC | LED18W 1500lm | 220-240V ~50Hz**

REF: 075313



REF 78127



REF 4921

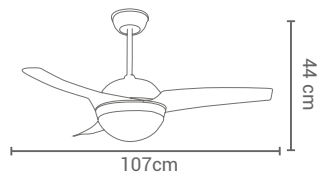

| SPEED | W  | RPM | AIRFLOW (m³/min) | dB |
|-------|----|-----|------------------|----|
| 1     | 22 | 205 | 70               | 30 |
| 2     | 40 | 240 | 120              | 40 |
| 3     | 60 | 295 | 168              | 45 |



MEDIUM SIZE

**BOMBAY | Motor AC | LED 36W 2400lm | 220-240V~50Hz**

REF: 075079

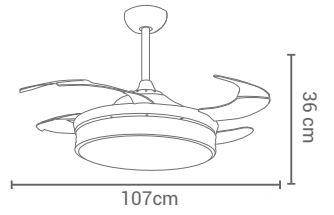

REF 78123



REF 22100



| SPEED | W  | RPM | AIRFLOW (m <sup>3</sup> /min) | dB |
|-------|----|-----|-------------------------------|----|
| 1     | 23 | 159 | 82                            | 27 |
| 2     | 42 | 207 | 107                           | 30 |
| 3     | 61 | 241 | 135                           | 39 |





**BALLOOnk | Motor AC | 2XE27 40W<sub>max</sub> | 220-240V ~50Hz**

REF: 072818

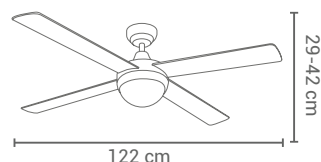
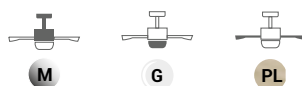

| SPEED | W  | RPM | AIRFLOW (m <sup>3</sup> /min) | dB |
|-------|----|-----|-------------------------------|----|
| 1     | 23 | 145 | 50                            | 45 |
| 2     | 40 | 196 | 66                            | 48 |
| 3     | 53 | 221 | 105                           | 52 |



REF 78127 REF 4962

**BALLOOb** | Motor AC | 2XE27 40W<sub>max</sub> | 220-240V ~50Hz  
REF: 072817

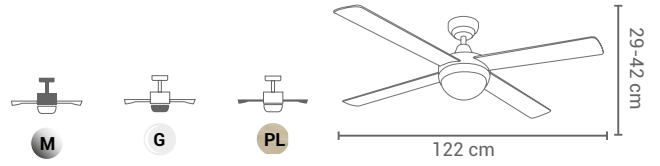

| SPEED | W  | RPM | AIRFLOW (m <sup>3</sup> /min) | dB |
|-------|----|-----|-------------------------------|----|
| 1     | 23 | 145 | 50                            | 45 |
| 2     | 40 | 196 | 66                            | 48 |
| 3     | 53 | 221 | 105                           | 52 |

**BALLOOm** | Motor AC | 2XE27 40W<sub>max</sub> | 220-240V ~50Hz  
REF: 072819

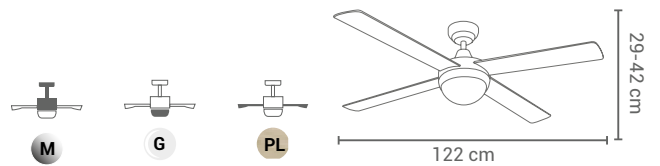

| SPEED | W  | RPM | AIRFLOW (m <sup>3</sup> /min) | dB |
|-------|----|-----|-------------------------------|----|
| 1     | 23 | 145 | 50                            | 45 |
| 2     | 40 | 196 | 66                            | 48 |
| 3     | 53 | 221 | 105                           | 52 |

**BALLOOmulty** | Motor AC | 2XE27 40W<sub>max</sub> | 220-240V ~50Hz  
REF: 072820

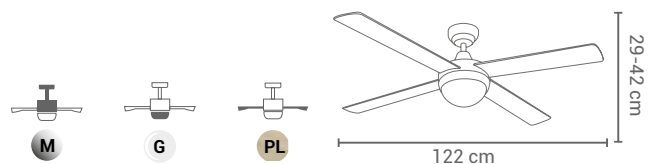

| SPEED | W  | RPM | AIRFLOW (m <sup>3</sup> /min) | dB |
|-------|----|-----|-------------------------------|----|
| 1     | 23 | 145 | 50                            | 45 |
| 2     | 40 | 196 | 66                            | 48 |
| 3     | 53 | 221 | 105                           | 52 |



**CORMORAN** | Motor AC | 2XE27 40W<sub>max.</sub> | 220-240V~50Hz  
 REF: 072132

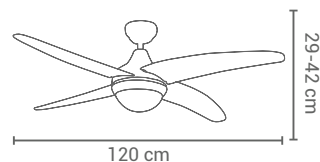
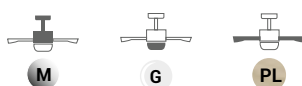

| SPEED | W  | RPM | AIRFLOW (m <sup>3</sup> /min) | dB |
|-------|----|-----|-------------------------------|----|
| 1     | 16 | 99  | 42                            | 45 |
| 2     | 32 | 169 | 81                            | 48 |
| 3     | 48 | 220 | 122                           | 52 |



REF 78100



REF 4830



MEDIUM SIZE

ANKE | Motor AC | 2XE27 40W<sub>max</sub> | 220-240V ~50Hz

REF: 072826

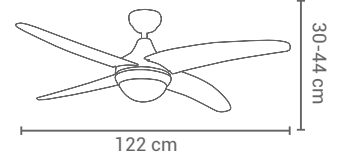

| SPEED | W  | RPM | AIRFLOW (m <sup>3</sup> /min) | dB |
|-------|----|-----|-------------------------------|----|
| 1     | 16 | 99  | 42                            | 45 |
| 2     | 32 | 169 | 81                            | 48 |
| 3     | 48 | 220 | 122                           | 52 |



REF 78100



REF 4830



**HORNET | Motor AC | 3XE27 60W<sub>max</sub> | 220-240V ~50Hz**

REF: 075438

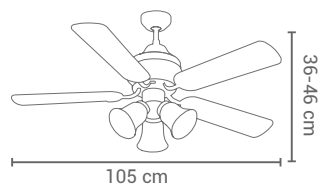
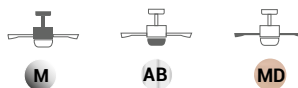

| SPEED | W  | RPM | AIRFLOW (m <sup>3</sup> /min) | dB |
|-------|----|-----|-------------------------------|----|
| 1     | 22 | 71  | 40                            | 43 |
| 2     | 27 | 134 | 60                            | 45 |
| 3     | 36 | 189 | 79                            | 48 |

REF 4209

**HORNET | Motor AC | 3XE27 60W<sub>max</sub> | 220-240V ~50Hz**

REF: 075439

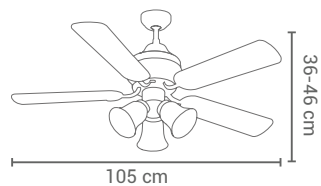
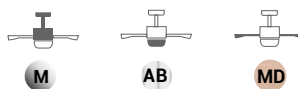

| SPEED | W  | RPM | AIRFLOW (m <sup>3</sup> /min) | dB |
|-------|----|-----|-------------------------------|----|
| 1     | 22 | 71  | 40                            | 43 |
| 2     | 27 | 134 | 60                            | 45 |
| 3     | 36 | 189 | 79                            | 48 |

REF 4209





MEDIUM SIZE



**WESTLAND | Motor AC | 3XE27 40W<sub>max</sub> | 220-240V~50Hz**  
**REF: 075660**

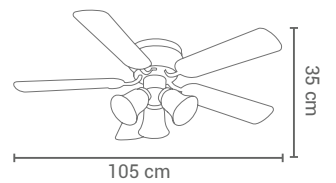

| SPEED | W  | RPM | AIRFLOW (m <sup>3</sup> /min) | dB |
|-------|----|-----|-------------------------------|----|
| 1     | 15 | 93  | 31                            | 43 |
| 2     | 33 | 150 | 59                            | 45 |
| 3     | 48 | 193 | 90                            | 48 |



REF 4209



**METEORb | Motor AC | 220-240V ~50Hz**

REF: 075118

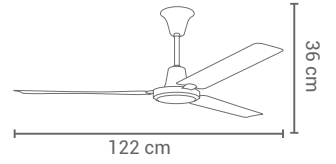

| SPEED | W  | RPM | AIRFLOW (m³/min) | dB |
|-------|----|-----|------------------|----|
| 1     | 9  | 120 | 63               | 41 |
| 2     | 15 | 170 | 86               | 43 |
| 3     | 29 | 250 | 125              | 45 |
| 4     | 59 | 316 | 156              | 49 |



**METEORnk | Motor AC | 220-240V ~50Hz**

REF: 075151

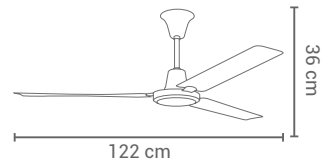

| SPEED | W  | RPM | AIRFLOW (m³/min) | dB |
|-------|----|-----|------------------|----|
| 1     | 9  | 120 | 63               | 41 |
| 2     | 15 | 170 | 86               | 43 |
| 3     | 29 | 250 | 125              | 45 |
| 4     | 59 | 316 | 156              | 49 |



A I R | 2019



Ø 1 2 7 0 - 1 8 2 0 m m

**B I G S I Z E**

Gran tamaño

Grande dimension

Tamanho grande

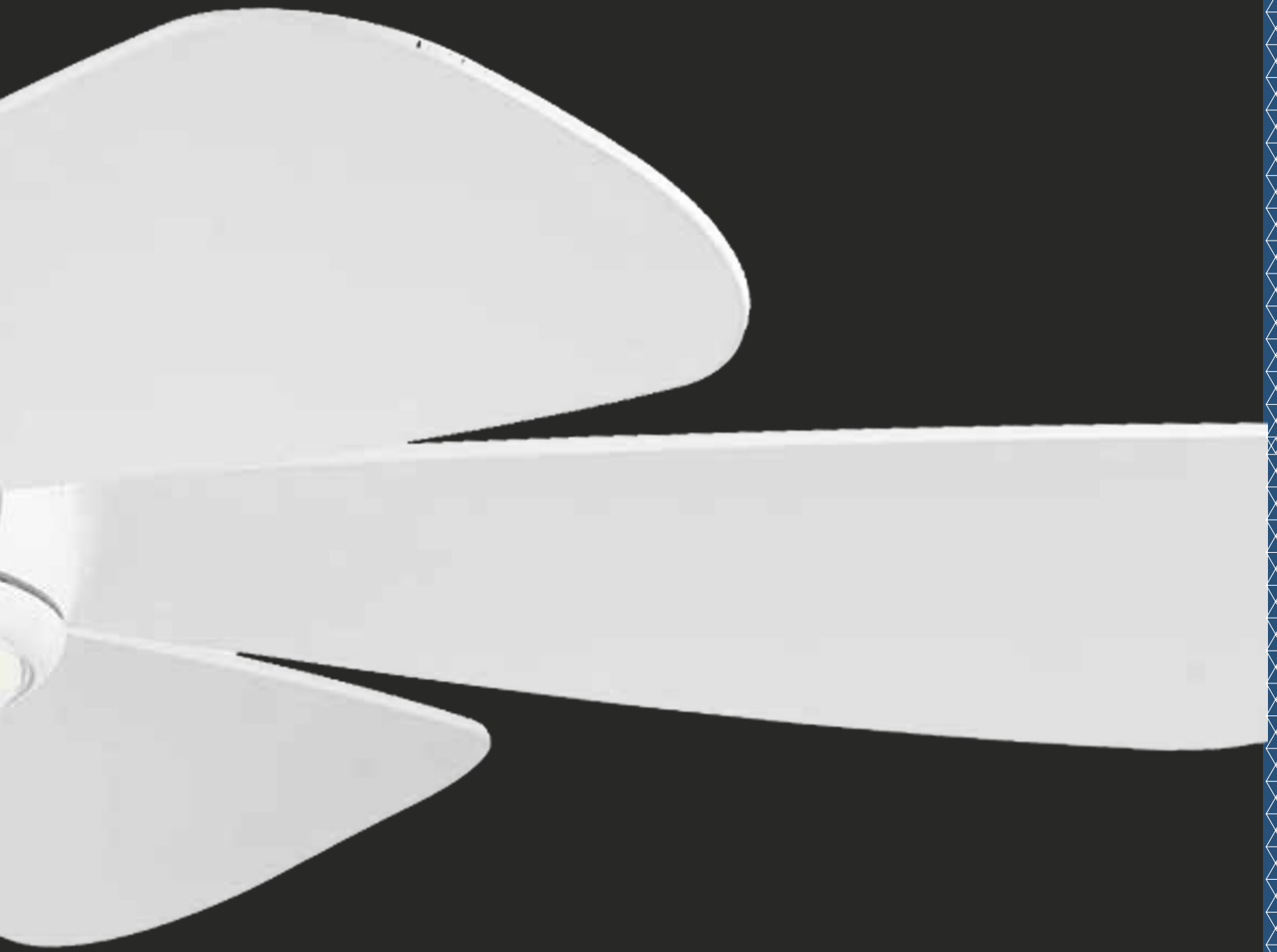





**RAHU<sub>b</sub>** | Motor DC | LED 18W 1500lm | 220-240V ~50Hz

REF: 072814



REF 78128 REF 4929

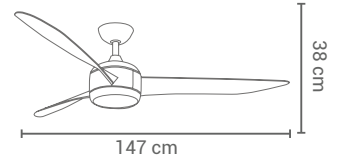
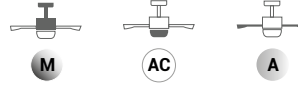

| SPEED | W  | RPM | AIRFLOW (m <sup>3</sup> /min) | dB |
|-------|----|-----|-------------------------------|----|
| 1     | 7  | 95  | 80                            | 36 |
| 2     | 10 | 120 | 120                           | 37 |
| 3     | 16 | 145 | 145                           | 38 |
| 4     | 24 | 170 | 170                           | 42 |
| 5     | 38 | 200 | 200                           | 43 |

**RAHU<sub>m</sub>** | Motor DC | LED 18W 1500lm | 220-240V ~50Hz

REF: 075408



REF 78128 REF 4929

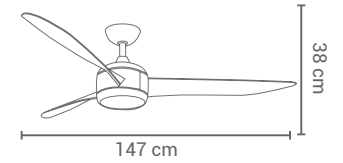
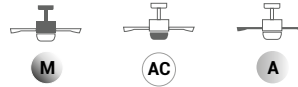

| SPEED | W  | RPM | AIRFLOW (m <sup>3</sup> /min) | dB |
|-------|----|-----|-------------------------------|----|
| 1     | 7  | 95  | 80                            | 36 |
| 2     | 10 | 120 | 120                           | 37 |
| 3     | 16 | 145 | 145                           | 38 |
| 4     | 24 | 170 | 170                           | 42 |
| 5     | 38 | 200 | 200                           | 43 |



**LOWA | Motor DC | LED 15W 1400lm | 220-240V ~50Hz**

REF: 075085

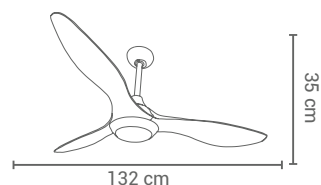

REF 78124



REF 4941

| SPEED | W   | RPM | AIRFLOW (m³/min) | dB |
|-------|-----|-----|------------------|----|
| 1     | 4   | 75  | 35               | 38 |
| 2     | 7.5 | 100 | 44               | 40 |
| 3     | 13  | 125 | 52               | 43 |
| 4     | 22  | 145 | 101              | 45 |
| 5     | 36  | 170 | 145              | 46 |

FIERA | Motor DC | LED 18W 1600lm | 220-240V ~50Hz

REF: 072237

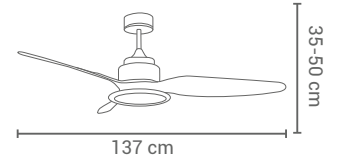

| SPEED | W  | RPM | AIRFLOW (m <sup>3</sup> /min) | dB |
|-------|----|-----|-------------------------------|----|
| 1     | 6  | 100 | 37                            | 29 |
| 2     | 9  | 125 | 62                            | 32 |
| 3     | 14 | 145 | 85                            | 39 |
| 4     | 20 | 165 | 99                            | 45 |
| 5     | 29 | 183 | 147                           | 49 |
| 6     | 48 | 210 | 204                           | 53 |



REF 78116



REF 4266



**BERNATb** | Motor DC | LED 18W 1600lm | 220-240V~50Hz  
REF: 075063



REF 78128 REF 4933

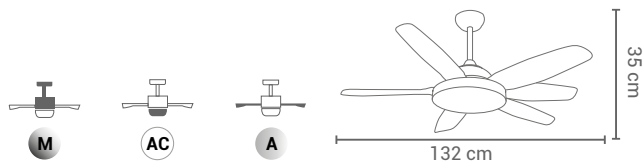

| SPEED | W  | RPM | AIRFLOW (m³/min) | dB |
|-------|----|-----|------------------|----|
| 1     | 5  | 83  | 75               | 29 |
| 2     | 9  | 102 | 100              | 32 |
| 3     | 14 | 123 | 125              | 39 |
| 4     | 22 | 143 | 150              | 45 |
| 5     | 38 | 173 | 183              | 49 |

**BERNATb** | Motor DC | LED 18W 1600lm | 220-240V~50Hz  
REF: 075064



REF 78128 REF 4933

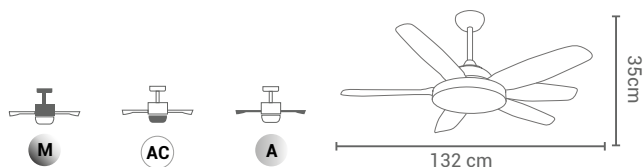

| SPEED | W  | RPM | AIRFLOW (m³/min) | dB |
|-------|----|-----|------------------|----|
| 1     | 5  | 83  | 75               | 29 |
| 2     | 9  | 102 | 100              | 32 |
| 3     | 14 | 123 | 125              | 39 |
| 4     | 22 | 143 | 150              | 45 |
| 5     | 38 | 173 | 183              | 49 |









**DIAMOND<sub>m</sub>** | Motor DC | LED 18W 1500lm | 220-240V~50Hz  
REF: 072248

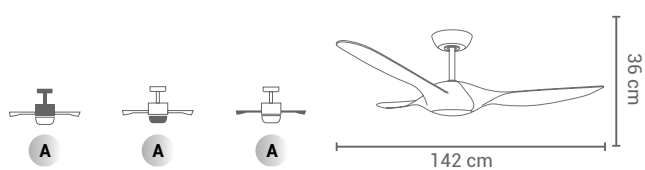

| SPEED | W  | RPM | AIRFLOW (m <sup>3</sup> /min) | dB |
|-------|----|-----|-------------------------------|----|
| 1     | 2  | 60  | 69                            | 36 |
| 2     | 5  | 115 | 104                           | 37 |
| 3     | 8  | 140 | 133                           | 38 |
| 4     | 15 | 165 | 163                           | 42 |
| 5     | 23 | 195 | 191                           | 43 |
| 6     | 40 | 225 | 225                           | 45 |



**DIAMOND<sub>n</sub>** | Motor DC | LED 18W 1500lm | 220-240V~50Hz  
REF: 072249

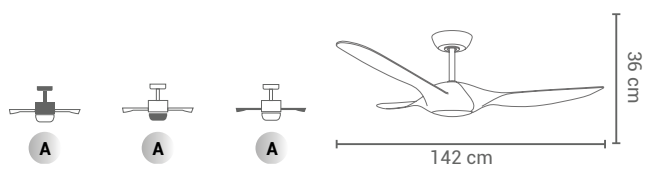

| SPEED | W  | RPM | AIRFLOW (m <sup>3</sup> /min) | dB |
|-------|----|-----|-------------------------------|----|
| 1     | 2  | 60  | 69                            | 36 |
| 2     | 5  | 115 | 104                           | 37 |
| 3     | 8  | 140 | 133                           | 38 |
| 4     | 15 | 165 | 163                           | 42 |
| 5     | 23 | 195 | 191                           | 43 |
| 6     | 40 | 225 | 225                           | 45 |





**NERHEA** | Motor DC | LED 18W 1500lm | 220-240V ~50Hz

REF: 072253

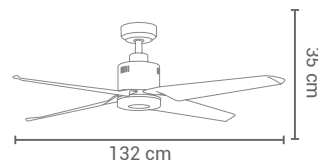
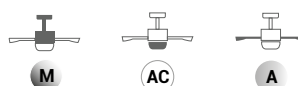

| SPEED | W   | RPM | AIRFLOW (m³/min) | dB |
|-------|-----|-----|------------------|----|
| 1     | 5   | 87  | 75               | 12 |
| 2     | 8.5 | 113 | 98               | 15 |
| 3     | 14  | 137 | 128              | 20 |
| 4     | 22  | 160 | 150              | 26 |
| 5     | 38  | 195 | 182              | 32 |



REF 78122



REF 4364

BIG SIZE

SARAH | Motor DC | LED 24W 1900lm | 220-240V ~50Hz

REF: 075325

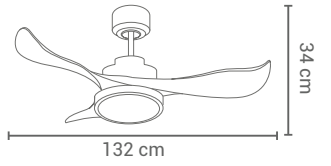

REF 78124



REF 4937

| SPEED | W  | RPM | AIRFLOW (m <sup>3</sup> /min) | dB |
|-------|----|-----|-------------------------------|----|
| 1     | 3  | 70  | 43                            | 38 |
| 2     | 4  | 90  | 51                            | 40 |
| 3     | 6  | 110 | 75                            | 43 |
| 4     | 9  | 130 | 95                            | 45 |
| 5     | 14 | 165 | 125                           | 46 |



FAN

**MAVERICK** | Motor DC | LED 18W 1500lm | 220-240V ~50Hz

REF: 075300



REF 78103



REF 4310

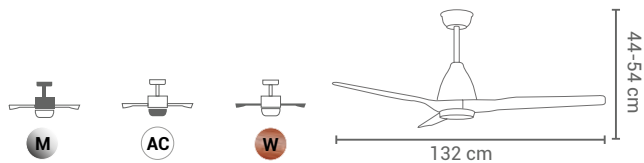

| SPEED | W  | RPM | AIRFLOW (m³/min) | dB |
|-------|----|-----|------------------|----|
| 1     | 4  | 90  | 34               | 22 |
| 2     | 7  | 118 | 42               | 25 |
| 3     | 10 | 145 | 51               | 28 |
| 4     | 16 | 165 | 99               | 32 |
| 5     | 26 | 200 | 142              | 38 |









**GADES | Motor DC | LED 18W 1400lm | 220-240V ~50Hz**  
**REF: 075264**

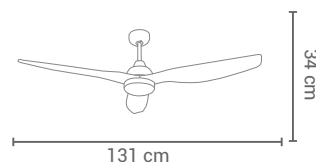
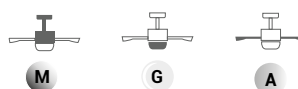

| SPEED | W    | RPM | AIRFLOW (m³/min) | dB |
|-------|------|-----|------------------|----|
| 1     | 4.4  | 74  | 68               | 41 |
| 2     | 6.3  | 93  | 85               | 44 |
| 3     | 11.9 | 123 | 109              | 46 |
| 4     | 22.4 | 154 | 134              | 48 |
| 5     | 30.5 | 170 | 147              | 51 |



REF 78121



REF 4370



BIG SIZE

SONET | Motor DC | LED 24W 1600lm | 220-240V ~50Hz

REF: 072217

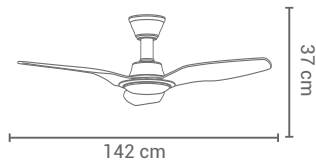

REF 78112



REF 4641

| SPEED | W    | RPM | AIRFLOW (m <sup>3</sup> /min) | dB |
|-------|------|-----|-------------------------------|----|
| 1     | 2,4  | 56  | 79                            | 27 |
| 2     | 4    | 84  | 104                           | 28 |
| 3     | 7,6  | 115 | 145                           | 30 |
| 4     | 12,5 | 141 | 172                           | 34 |
| 5     | 19   | 163 | 220                           | 38 |
| 6     | 25,8 | 181 | 242                           | 40 |





BIG SIZE

VADIS | Motor DC | 220-240V ~50Hz

REF: 075153

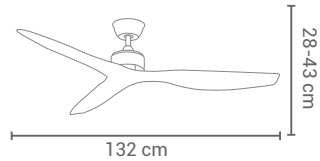

REF 78120

| SPEED | W    | RPM | AIRFLOW (m <sup>3</sup> /min) | dB |
|-------|------|-----|-------------------------------|----|
| 1     | 6.8  | 119 | 107                           | 28 |
| 2     | 11.7 | 153 | 127                           | 31 |
| 3     | 16.9 | 176 | 144                           | 34 |
| 4     | 20.5 | 188 | 164                           | 37 |
| 5     | 25.8 | 200 | 178                           | 43 |
| 6     | 34.7 | 220 | 193                           | 48 |



**BROMIEN | Motor DC | 220-240V ~50Hz**  
**REF: 072316**

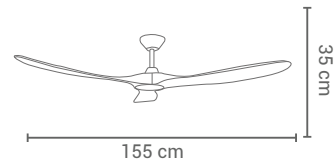

REF 78111

| SPEED | W    | RPM | AIRFLOW (m <sup>3</sup> /min) | dB |
|-------|------|-----|-------------------------------|----|
| 1     | 4.4  | 80  | 10                            | 35 |
| 2     | 6.3  | 99  | 82                            | 38 |
| 3     | 9    | 118 | 110                           | 39 |
| 4     | 13.7 | 141 | 147                           | 41 |
| 5     | 18.9 | 159 | 190                           | 43 |
| 6     | 26.6 | 182 | 250                           | 45 |





**MUSTANG** | Motor AC | LED 18W 1500lm | 220-240V ~50Hz

REF: 072208



| SPEED | W  | RPM | AIRFLOW (m <sup>3</sup> /min) | dB |
|-------|----|-----|-------------------------------|----|
| 1     | 23 | 77  | 75                            | 30 |
| 2     | 56 | 138 | 120                           | 38 |
| 3     | 80 | 166 | 180                           | 45 |



REF 78099



REF 4211



**GALILEOb** | Motor AC | LED 18W 1500lm | 220-240V ~50Hz

REF: 075061

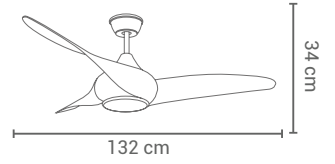
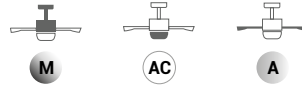

| SPEED | W  | RPM | AIRFLOW (m <sup>3</sup> /min) | dB |
|-------|----|-----|-------------------------------|----|
| 1     | 25 | 75  | 35                            | 25 |
| 2     | 45 | 120 | 99                            | 29 |
| 3     | 68 | 160 | 142                           | 35 |



REF 78127

**GALILEOm** | Motor AC | LED 18W 1500lm | 220-240V ~50Hz

REF: 075306

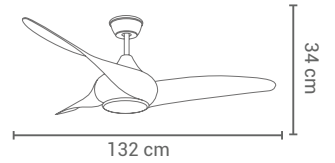
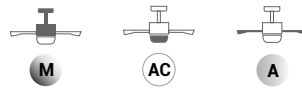

| SPEED | W  | RPM | AIRFLOW (m <sup>3</sup> /min) | dB |
|-------|----|-----|-------------------------------|----|
| 1     | 25 | 75  | 35                            | 25 |
| 2     | 45 | 120 | 99                            | 29 |
| 3     | 68 | 160 | 142                           | 35 |



REF 78127





**MARCONY** | Motor AC | LED 18W 1500lm | 220-240V ~50Hz  
 REF: 075066

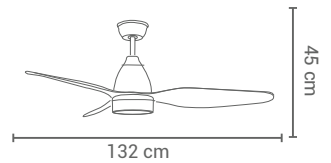

- 10.000 h
- 25.000 h
- 5~+40°C
- PF 0.90
- 3
- 15° Max
- 
- IP 20
- 150°
- 
- A+
- CRI 80

| SPEED | W  | RPM | AIRFLOW (m³/min) | dB |
|-------|----|-----|------------------|----|
| 1     | 22 | 90  | 43               | 25 |
| 2     | 51 | 140 | 110              | 29 |
| 3     | 80 | 215 | 160              | 35 |



REF 78127



REF 4918

**JALON | Motor AC | LED 18W 1500lm | 220-240V ~50Hz**  
**REF: 075311**

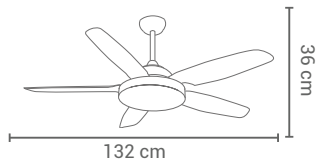

| SPEED | W  | RPM | AIRFLOW (m³/min) | dB |
|-------|----|-----|------------------|----|
| 1     | 22 | 70  | 80               | 25 |
| 2     | 42 | 115 | 130              | 29 |
| 3     | 85 | 155 | 185              | 35 |



REF 78127



REF 4908







**BALLOO+nk** | Motor AC | LED 18W 1800lm | 220-240V ~50Hz  
REF: 075099

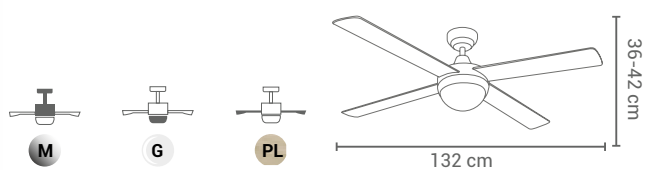

| SPEED | W  | RPM | AIRFLOW (m <sup>3</sup> /min) | dB |
|-------|----|-----|-------------------------------|----|
| 1     | 22 | 136 | 83                            | 45 |
| 2     | 39 | 169 | 113                           | 48 |
| 3     | 65 | 215 | 160                           | 52 |



REF 78127 REF 4914

**BALLOO+b** | Motor AC | LED 18W 1800lm | 220-240V ~50Hz  
REF: 075318

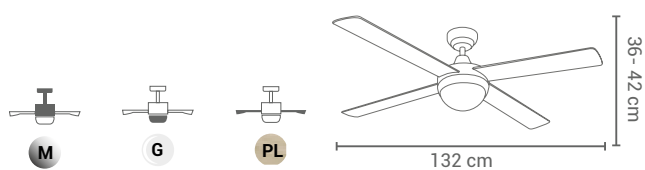

| SPEED | W  | RPM | AIRFLOW (m <sup>3</sup> /min) | dB |
|-------|----|-----|-------------------------------|----|
| 1     | 22 | 136 | 83                            | 45 |
| 2     | 39 | 169 | 113                           | 48 |
| 3     | 65 | 215 | 160                           | 52 |



REF 78127 REF 4914





SKUAb | Motor AC | 3XE27 40Wmax. | 220-240V ~50Hz  
 REF: 072816

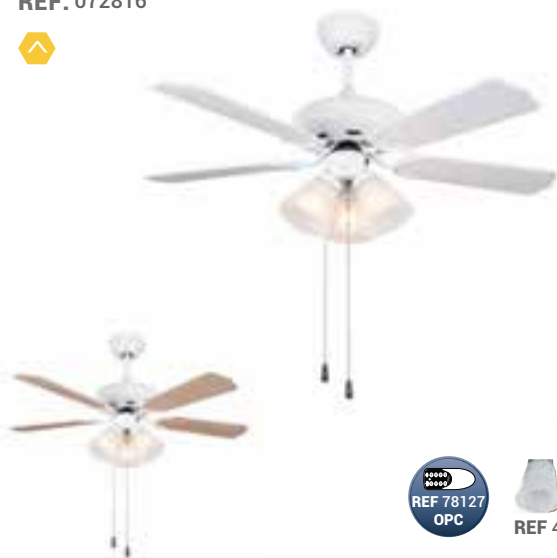

REF 78127  
 OPC

REF 4911

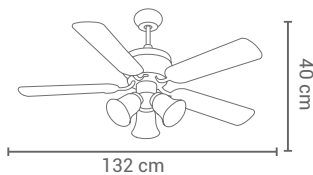
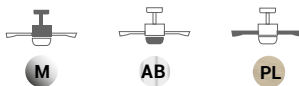

| SPEED | W  | RPM | AIRFLOW (m³/min) | dB |
|-------|----|-----|------------------|----|
| 1     | 28 | 105 | 85               | 38 |
| 2     | 46 | 160 | 127              | 43 |
| 3     | 65 | 195 | 155              | 49 |

SKUANk | Motor AC | 3XE27 40Wmax. | 220-240V ~50Hz  
 REF: 072822



REF 78127  
 OPC

REF 4911

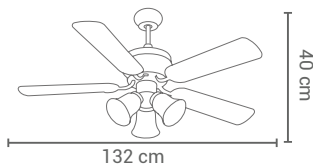
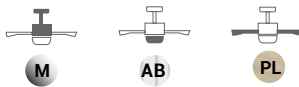

| SPEED | W  | RPM | AIRFLOW (m³/min) | dB |
|-------|----|-----|------------------|----|
| 1     | 28 | 105 | 85               | 38 |
| 2     | 46 | 160 | 127              | 43 |
| 3     | 65 | 195 | 155              | 49 |



**OLYMPIA | Motor AC | 3XE27 60Wmax. | 220-240V ~50Hz**  
**REF: 072240**



REF 78127  
OPC

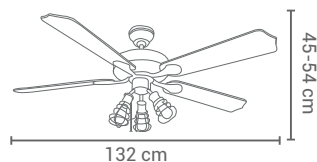

| SPEED | W  | RPM | AIRFLOW (m <sup>3</sup> /min) | dB |
|-------|----|-----|-------------------------------|----|
| 1     | 20 | 99  | 38                            | 47 |
| 2     | 30 | 133 | 84                            | 51 |
| 3     | 58 | 191 | 130                           | 56 |

**DALLAS | Motor AC | 2XE27 40W<sub>max.</sub> | 220-240V ~50Hz**  
 REF: 075026

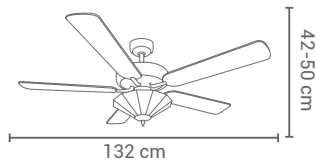

| SPEED | W  | RPM | AIRFLOW (m <sup>3</sup> /min) | dB |
|-------|----|-----|-------------------------------|----|
| 1     | 17 | 99  | 51                            | 45 |
| 2     | 30 | 133 | 88                            | 48 |
| 3     | 58 | 191 | 130                           | 52 |



## ACCESORIOS

accessories | accessoires | acessórios



| Ref  | Size | Color           |
|------|------|-----------------|
| 4518 | 25cm | blanco          |
| 4535 | 25cm | cuero viejo     |
| 4570 | 25cm | marrón          |
| 4704 | 25cm | gris antracita  |
| 4761 | 25cm | blanco satinado |
| 4763 | 25cm | níquel          |
| 4765 | 25cm | negro           |
| 4859 | 25cm | madera oscura   |
| 4866 | 25cm | madera clara    |
| 4869 | 25cm | cromo           |
| 4967 | 25cm | marron          |
| 4968 | 25cm | gris            |
| 4963 | 60cm | blanco          |
| 4964 | 60cm | blanco satinado |
| 4965 | 60cm | níquel          |
| 4966 | 60cm | madera oscura   |
| 4969 | 60cm | madera clara    |





| Ref   | Name      | Page | Ref   | Name      | Page | Ref    | Name        | Page | Ref    | Name      | Page |
|-------|-----------|------|-------|-----------|------|--------|-------------|------|--------|-----------|------|
| 4552  | VIDRIERA  | 127  | 50300 | DIFUSOR   | 236  | 60500  | BASIC       | 85   | 075408 | RAHU m    | 355  |
| 4556  | VIDRIERA  | 127  | 50301 | DIFUSOR   | 236  | 60612  | CONEXIÓN    | 215  | 075438 | HORNET ml | 348  |
| 4559  | VIDRIERA  | 127  | 50301 | DIFUSOR   | 236  | 60613  | CONEXIÓN    | 215  | 075439 | HORNET nk | 348  |
| 8752  | EBRO      | 131  | 50302 | DIFUSOR   | 236  | 072132 | CORMORAN    | 346  | 075660 | WESTLAND  | 349  |
| 8758  | EBRO      | 131  | 50302 | DIFUSOR   | 236  | 072208 | MUSTANGT    | 372  | 80536  | DRIVER    | 319  |
| 8759  | EBRO      | 131  | 50303 | DIFUSOR   | 237  | 072217 | SONET       | 367  | 80600  | CONTROLA- | 317  |
| 10080 | ACCESORIO | 180  | 50304 | DIFUSOR   | 237  | 072237 | FIERA       | 357  | 80602  | ACCESORIO | 235  |
| 10080 | ACCESORIO | 266  | 50305 | DIFUSOR   | 237  | 072240 | OLYMPIA     | 380  | 80604  | ACCESORIO | 235  |
| 10081 | ACCESORIO | 180  | 50405 | ACCESORIO | 236  | 072248 | DIAMOND d   | 361  | 80605  | ACCESORIO | 235  |
| 10081 | ACCESORIO | 266  | 50406 | ACCESORIO | 236  | 072249 | DIAMOND n   | 361  | 80606  | ACCESORIO | 235  |
| 10083 | ACCESORIO | 180  | 50407 | ACCESORIO | 236  | 072253 | NERHEA      | 362  | 80607  | ACCESORIO | 235  |
| 10083 | ACCESORIO | 266  | 50408 | ACCESORIO | 236  | 072316 | BROMIEN     | 371  | 80608  | ACCESORIO | 235  |
| 10084 | ACCESORIO | 180  | 50409 | ACCESORIO | 236  | 072643 | HANDAIR     | 331  | 80609  | ACCESORIO | 235  |
| 10084 | ACCESORIO | 266  | 50410 | ACCESORIO | 236  | 072814 | RAHU b      | 355  | 80610  | ACCESORIO | 235  |
| 21299 | GU10      | 164  | 50412 | ACCESORIO | 237  | 072816 | SKUA b      | 379  | 80611  | ACCESORIO | 235  |
| 21300 | ACCESORIO | 164  | 50415 | ACCESORIO | 236  | 072817 | BALLOO b    | 345  | 80612  | ACCESORIO | 235  |
| 21400 | ACCESORIO | 164  | 50416 | ACCESORIO | 236  | 072818 | BALLOO nk   | 344  | 80613  | ACCESORIO | 235  |
| 24010 | DRIVER    | 316  | 50417 | ACCESORIO | 236  | 072819 | BALLOO m    | 345  | 80621  | DRIVER    | 319  |
| 24020 | DRIVER    | 316  | 50418 | ACCESORIO | 236  | 072820 | BALLOO ml   | 345  | 80633  | CONTROL   | 316  |
| 24035 | DRIVER    | 316  | 50419 | ACCESORIO | 236  | 072822 | SKUA nk     | 379  | 80634  | ACCESORIO | 235  |
| 24060 | DRIVER    | 316  | 50420 | ACCESORIO | 236  | 072824 | CIRROS      | 341  | 81536  | DRIVER    | 318  |
| 24100 | DRIVER    | 316  | 50422 | ACCESORIO | 237  | 072825 | HANNA       | 330  | 81570  | DRIVER    | 319  |
| 24125 | DRIVER    | 316  | 50423 | CONTROL   | 317  | 072826 | ANKE        | 347  | 100736 | STRIP LED | 233  |
| 24135 | DRIVER    | 316  | 50424 | CONTROL   | 317  | 072827 | RUBIK c     | 329  | 100737 | STRIP LED | 233  |
| 24150 | DRIVER    | 316  | 50426 | CONTROL   | 317  | 072830 | ATUAIRE     | 333  | 100738 | STRIP LED | 233  |
| 24175 | DRIVER    | 316  | 50434 | ACCESORIO | 237  | 075008 | RAINBOW led | 335  | 100752 | THOR      | 173  |
| 24200 | DRIVER    | 316  | 50435 | ACCESORIO | 237  | 075026 | DALLAS      | 381  | 100753 | THOR      | 173  |
| 24250 | DRIVER    | 316  | 50436 | ACCESORIO | 317  | 075061 | GALILEO b   | 373  | 100757 | BUILT     | 298  |
| 24350 | DRIVER    | 316  | 50437 | CONTROL   | 317  | 075063 | BERNAT a    | 358  | 100759 | THOR      | 173  |
| 24610 | DRIVER    | 316  | 50441 | CONTROL   | 318  | 075064 | BERNAT b    | 358  | 100760 | THOR      | 173  |
| 24615 | DRIVER    | 316  | 50442 | CONTROL   | 318  | 075066 | MARCONY     | 374  | 100763 | GRASS     | 294  |
| 24620 | DRIVER    | 316  | 50600 | PERFIL    | 236  | 075079 | BOMBAY      | 343  | 100764 | CANADIAN  | 296  |
| 24625 | DRIVER    | 316  | 50601 | PERFIL    | 236  | 075085 | LOWA        | 356  | 100765 | CANADIAN  | 296  |
| 24630 | DRIVER    | 316  | 50602 | PERFIL    | 236  | 075099 | BALLOO+     | 377  | 100770 | CIFO      | 197  |
| 24640 | DRIVER    | 316  | 50603 | PERFIL    | 237  | 075118 | METEOR b    | 351  | 100795 | PENN+     | 265  |
| 24680 | DRIVER    | 316  | 50607 | ACCESORIO | 318  | 075151 | METEOR nk   | 351  | 100805 | SURF      | 220  |
| 24710 | DRIVER    | 316  | 50608 | PERFIL    | 236  | 075153 | VADIS       | 369  | 100806 | SURF      | 221  |
| 24715 | DRIVER    | 316  | 50612 | PERFIL    | 236  | 075155 | RAINBOW b   | 335  | 100807 | SURF      | 220  |
| 24720 | DRIVER    | 316  | 50615 | ACCESORIO | 203  | 075165 | RAINBOW ml  | 335  | 100808 | SURF      | 221  |
| 24725 | DRIVER    | 316  | 50618 | DRIVER    | 318  | 075262 | FLORA       | 337  | 100809 | SURF      | 220  |
| 24730 | DRIVER    | 316  | 50623 | MARCO     | 203  | 075264 | GADES       | 366  | 100810 | SURF      | 221  |
| 24740 | DRIVER    | 316  | 50624 | ACCESORIO | 298  | 075300 | MAVERICK    | 364  | 100818 | ALPHA     | 189  |
| 24780 | DRIVER    | 316  | 50625 | ACCESORIO | 298  | 075306 | GALILEO m   | 373  | 100819 | ALPHA     | 189  |
| 24800 | DRIVER    | 316  | 50626 | ACCESORIO | 298  | 075311 | JALON       | 375  | 100821 | HOLE      | 218  |
| 24860 | DRIVER    | 316  | 50627 | ACCESORIO | 208  | 075313 | NEWTON      | 342  | 100822 | HOLE      | 218  |
| 25152 | VISIO     | 318  | 50628 | ACCESORIO | 208  | 075318 | BALLOO+ b   | 377  | 100823 | HOLE      | 218  |
| 25153 | VISIO     | 318  | 50629 | ACCESORIO | 208  | 075319 | RUBIK b     | 329  | 100824 | SURF      | 223  |
| 50300 | DIFUSOR   | 236  | 50653 | ACCESORIO | 261  | 075325 | SARAH       | 363  | 100825 | SURF      | 220  |



| Ref    | Name     | Page | Ref    | Name     | Page | Ref    | Name         | Page | Ref    | Name         | Page |
|--------|----------|------|--------|----------|------|--------|--------------|------|--------|--------------|------|
| 100826 | SURF     | 220  | 101074 | SURF     | 223  | 101604 | VISIO        | 165  | 108939 | STRIP LED PR | 234  |
| 100827 | SURF     | 220  | 101149 | BUGGY    | 175  | 101605 | VISIO        | 165  | 108939 | STRIP LED PR | 397  |
| 100832 | PEAK     | 208  | 101151 | FRONT    | 54   | 101606 | VISIO        | 165  | 108940 | STRIP LED PR | 234  |
| 100834 | PEAK     | 208  | 101153 | FRONT    | 54   | 101614 | VISIO        | 165  | 108940 | STRIP LED PR | 397  |
| 100836 | PEAK     | 208  | 101156 | FRONT    | 54   | 101618 | VISIO        | 165  | 108941 | STRIP LED PR | 234  |
| 100846 | PLATE    | 203  | 101172 | BUGGY    | 175  | 101621 | VISIO        | 165  | 108941 | STRIP LED PR | 397  |
| 100852 | SURF     | 220  | 101173 | BUGGY    | 175  | 101624 | VISIO        | 165  | 108977 | STRIP LED PR | 234  |
| 100854 | SURF     | 220  | 101174 | BUGGY    | 175  | 101627 | VISIO        | 165  | 108977 | STRIP LED PR | 397  |
| 100894 | SURF     | 220  | 101175 | BUGGY    | 175  | 101628 | VISIO        | 165  | 108978 | STRIP LED PR | 234  |
| 100895 | SURF     | 221  | 101176 | BUGGY    | 175  | 101629 | VISIO        | 165  | 108978 | STRIP LED PR | 397  |
| 100896 | SURF     | 221  | 101178 | SAND     | 168  | 101630 | VISIO        | 164  | 108979 | STRIP LED PR | 234  |
| 100897 | SURF     | 221  | 101179 | SAND     | 168  | 101631 | VISIO        | 164  | 108979 | STRIP LED PR | 397  |
| 100898 | SURF     | 220  | 101180 | SAND     | 168  | 101736 | STRIP LED PR | 233  | 108980 | STRIP LED PR | 234  |
| 100899 | SURF     | 220  | 101181 | SAND     | 168  | 101753 | THOR         | 173  | 108980 | STRIP LED PR | 397  |
| 100912 | SURF     | 220  | 101182 | BUILT    | 298  | 101759 | THOR         | 173  | 110039 | PLAFON       | 291  |
| 100943 | SURF     | 221  | 101183 | GRASS    | 294  | 101763 | RAPHA        | 292  | 111031 | UMFIX        | 161  |
| 100945 | SURF     | 221  | 101190 | COLOSSAL | 193  | 101859 | READ         | 63   | 111032 | ARUMFIX      | 161  |
| 100948 | SURF     | 221  | 101191 | COLOSSAL | 193  | 102011 | BELOW        | 185  | 111041 | LINDENFIX    | 191  |
| 100950 | DOTFIX   | 157  | 101192 | COLOSSAL | 193  | 102021 | BEWATER      | 259  | 111042 | RAYFIX       | 191  |
| 100951 | DOTFIX   | 157  | 101194 | PLAFON   | 291  | 102022 | BEWATER      | 259  | 111050 | THIN+        | 285  |
| 100952 | DOTFIX   | 157  | 101210 | DW360    | 205  | 102025 | BECOOOL      | 185  | 111051 | THIN+        | 285  |
| 100953 | DOTFIX   | 157  | 101211 | DW360    | 205  | 102027 | BECOOOL      | 185  | 111058 | COBSOIL      | 283  |
| 100954 | DOTFIX   | 157  | 101212 | DW360    | 205  | 102039 | PLURIEL      | 249  | 111077 | ARUMFIX      | 161  |
| 100955 | DOTFIX   | 157  | 101213 | DW360    | 205  | 102041 | BELOW        | 185  | 111078 | ARUMFIX      | 161  |
| 101024 | SENS     | 225  | 101214 | DW360    | 205  | 102094 | PLURIEL      | 249  | 111090 | ASTON        | 191  |
| 101026 | T5 LINE  | 215  | 101220 | FULL     | 227  | 102151 | FRONT        | 55   | 111119 | NATURE       | 247  |
| 101027 | SURF     | 221  | 101223 | FULL     | 227  | 102152 | FRONT        | 55   | 111123 | COBDEW       | 273  |
| 101028 | SURF     | 221  | 101224 | TWIS     | 229  | 102153 | FRONT        | 55   | 111135 | COBFOUNT     | 271  |
| 101029 | SURF     | 220  | 101225 | TWIS     | 229  | 102155 | FRONT        | 54   | 111140 | COBAQUA      | 287  |
| 101030 | SURF     | 221  | 101226 | TWIS     | 229  | 102265 | TURK         | 170  | 111141 | COBAQUA      | 287  |
| 101031 | SURF     | 220  | 101250 | DUCK     | 159  | 102266 | TURK         | 170  | 111153 | COBAQUA      | 287  |
| 101032 | T5 LINE  | 215  | 101252 | SURF     | 222  | 102795 | PENN+        | 265  | 111188 | COBFROST     | 277  |
| 101034 | T5 LINE  | 215  | 101254 | DUCK     | 159  | 102796 | PENN+        | 265  | 111189 | COBFROST     | 277  |
| 101054 | SURF     | 222  | 101259 | DEEP     | 261  | 102797 | PENN+        | 265  | 111197 | COBSOIL      | 283  |
| 101056 | PLATE    | 203  | 101260 | DEEP     | 261  | 102798 | PENN+        | 265  | 111205 | PEG          | 285  |
| 101060 | HOLEGLAS | 231  | 101261 | DEEP     | 261  | 102799 | PENN+        | 265  | 111325 | CONSOIL      | 283  |
| 101061 | HOLEGLAS | 231  | 101262 | DEEP     | 261  | 103795 | PENN         | 179  | 111608 | MARTÍN       | 56   |
| 101062 | HOLEGLAS | 231  | 101263 | DEEP     | 261  | 103796 | PENN         | 179  | 111609 | MARTÍN       | 56   |
| 101064 | SURF     | 220  | 101264 | DEEP     | 261  | 103797 | PENN         | 179  | 111620 | MARTÍN       | 56   |
| 101065 | SURF     | 221  | 101265 | TURK     | 170  | 103798 | PENN         | 179  | 111621 | MARTÍN       | 56   |
| 101066 | SURF     | 221  | 101266 | TURK     | 170  | 103799 | PENN         | 179  | 111624 | MARTÍN       | 56   |
| 101067 | SURF     | 221  | 101400 | KORU     | 211  | 104795 | PENN         | 179  | 111770 | CIFO         | 197  |
| 101068 | SURF     | 220  | 101401 | KORU     | 211  | 108741 | STRIP LED PR | 234  | 111988 | COBFROST     | 277  |
| 101069 | SURF     | 220  | 101402 | KORU     | 211  | 108741 | STRIP LED PR | 397  | 111989 | COBFROST     | 277  |
| 101070 | SURF     | 220  | 101403 | KORU     | 211  | 108936 | STRIP LED PR | 234  | 112011 | TRIME        | 183  |
| 101071 | SURF     | 221  | 101404 | KORU     | 211  | 108936 | STRIP LED PR | 397  | 112012 | TRIME        | 183  |
| 101072 | SURF     | 221  | 101405 | KORU     | 211  | 108937 | STRIP LED PR | 234  | 112013 | TRIME        | 183  |
| 101073 | SURF     | 221  | 101602 | VISIO    | 164  | 108937 | STRIP LED PR | 397  | 112050 | DOUCHE       | 241  |

| Ref    | Name    | Page | Ref    | Name    | Page | Ref    | Name     | Page | Ref    | Name    | Page |
|--------|---------|------|--------|---------|------|--------|----------|------|--------|---------|------|
| 112051 | PLURIEL | 249  | 112420 | MASINI  | 301  | 166376 | GUERTY   | 67   | 190130 | TORÚN   | 22   |
| 112052 | DOUCHE  | 241  | 112421 | MASINI  | 301  | 166380 | GUERTY   | 67   | 190135 | TORÚN   | 22   |
| 112080 | CARRY   | 87   | 112422 | MASINI  | 301  | 166390 | ARM      | 67   | 200101 | VOLEA   | 39   |
| 112081 | CARRY   | 87   | 112432 | KIPPER  | 307  | 166392 | LOLA     | 69   | 200104 | VOLEA   | 39   |
| 112091 | PLURIEL | 249  | 112915 | PLURIEL | 249  | 166393 | LOLA     | 69   | 200111 | VOLEA   | 37   |
| 112154 | COBAQUA | 287  | 112916 | PLURIEL | 249  | 166394 | BED      | 63   | 200112 | VOLEA   | 37   |
| 112168 | TAPE    | 199  | 112923 | PLURIEL | 249  | 166395 | BED      | 63   | 200200 | SCALE   | 49   |
| 112180 | NEW ERA | 275  | 112926 | PLURIEL | 249  | 166609 | VOLEA    | 37   | 200201 | SCALE   | 49   |
| 112208 | NEW ERA | 275  | 112958 | TISA    | 263  | 166618 | VOLEA    | 37   | 200202 | SCALE   | 49   |
| 112226 | FULINO  | 89   | 112968 | TAPE    | 199  | 166631 | VOLEA    | 37   | 200203 | SCALE   | 49   |
| 112228 | FULINO  | 89   | 112972 | TISA    | 263  | 166632 | VOLEA    | 37   | 200582 | BIRD    | 309  |
| 112230 | FULINO  | 89   | 113150 | BARI    | 203  | 166641 | VOLEA    | 39   | 200597 | KIPPER  | 307  |
| 112262 | NEKO    | 313  | 113188 | KAMAL   | 268  | 166642 | VOLEA    | 39   | 209223 | VENUS   | 151  |
| 112271 | TISA    | 263  | 113192 | KAMAL   | 268  | 166720 | CURLY    | 103  | 209233 | VENUS   | 151  |
| 112272 | TISA    | 263  | 113256 | KAMAL   | 268  | 167100 | JAKKMOKK | 135  | 209243 | VENUS   | 151  |
| 112273 | KOPYO   | 279  | 113952 | KAMAL   | 268  | 167101 | JAKKMOKK | 135  | 209413 | VENUS   | 151  |
| 112276 | KOPYO   | 279  | 113953 | KAMAL   | 268  | 167102 | JAKKMOKK | 135  | 209513 | VENUS   | 151  |
| 112278 | KOPYO   | 279  | 113954 | KAMAL   | 268  | 168100 | LULEA    | 138  | 209613 | VENUS   | 151  |
| 112286 | DOTFIX  | 157  | 113955 | KAMAL   | 268  | 168101 | LULEA    | 138  | 210100 | DIEM    | 27   |
| 112287 | TISA    | 263  | 113990 | KAMAL   | 268  | 168102 | LULEA    | 138  | 210101 | DIEM    | 27   |
| 112288 | DOTFIX  | 157  | 113991 | KAMAL   | 268  | 187040 | STELA    | 24   | 210102 | DIEM    | 27   |
| 112293 | RECORD  | 289  | 113992 | KAMAL   | 268  | 187075 | NORDIC   | 43   | 210103 | DIEM    | 27   |
| 112293 | RECORD  | 397  | 114020 | HALE    | 30   | 187076 | NORDIC   | 44   | 210104 | DIEM    | 27   |
| 112295 | RECORD  | 289  | 114022 | HALE    | 30   | 187090 | YANGON   | 35   | 210106 | DIEM    | 27   |
| 112295 | RECORD  | 397  | 114030 | HALE    | 30   | 187091 | NORDIC   | 43   | 210107 | DIEM    | 26   |
| 112300 | KITCH   | 187  | 114032 | HALE    | 30   | 187092 | SAVOY    | 35   | 210108 | DIEM    | 26   |
| 112305 | KITCH   | 187  | 114104 | TAVEDA  | 33   | 187094 | NORDIC   | 43   | 215005 | GYP SUM | 57   |
| 112308 | YUKA    | 285  | 120039 | OUTDOOR | 291  | 189002 | PENDEL   | 59   | 215009 | GYP SUM | 57   |
| 112320 | MASINI  | 301  | 121194 | OUTDOOR | 291  | 189003 | PENDEL   | 59   | 215112 | GYP SUM | 57   |
| 112321 | MASINI  | 301  | 122052 | OUTDOOR | 291  | 189024 | PENDEL   | 59   | 216000 | KODY    | 93   |
| 112322 | MASINI  | 301  | 122053 | OUTDOOR | 291  | 189029 | PENDEL   | 59   | 216001 | KODY    | 93   |
| 112323 | MASINI  | 301  | 122054 | OUTDOOR | 291  | 189030 | PENDEL   | 59   | 216002 | KODY    | 93   |
| 112324 | MASINI  | 301  | 122055 | OUTDOOR | 291  | 189033 | PENDEL   | 59   | 216003 | KODY    | 93   |
| 112325 | MASINI  | 301  | 141280 | BARGELD | 123  | 189039 | POLON    | 91   | 216004 | KODY    | 93   |
| 112327 | MASINI  | 301  | 141281 | PICABIA | 121  | 189046 | POLON    | 91   | 216005 | KODY    | 93   |
| 112329 | MASINI  | 301  | 141290 | BARGELD | 123  | 189048 | NATURE   | 95   | 216007 | KODY    | 93   |
| 112350 | KOPYO   | 279  | 141291 | PICABIA | 121  | 189049 | NATURE   | 95   | 216008 | KODY    | 93   |
| 112353 | KOPYO   | 279  | 141430 | TAFLA   | 119  | 189050 | NATURE   | 95   | 217000 | SELMA   | 99   |
| 112355 | KOPYO   | 279  | 142000 | CURVES  | 251  | 189096 | POLON    | 91   | 217010 | KLEE    | 97   |
| 112358 | TISA    | 263  | 142001 | CURVES  | 251  | 189100 | PENDEL   | 59   | 217011 | KLEE    | 97   |
| 112361 | PLATE   | 203  | 142010 | BULA    | 253  | 189905 | FLYNN    | 41   | 217012 | KLEE    | 97   |
| 112364 | ARC     | 168  | 166310 | BASIC   | 84   | 189914 | FLYNN    | 41   | 217020 | KLEE    | 97   |
| 112367 | PLATE   | 203  | 166312 | BASIC   | 84   | 189917 | KARLOFF  | 147  | 217105 | DRAPER  | 109  |
| 112368 | ARC     | 168  | 166318 | BASIC   | 84   | 189918 | KARLOFF  | 147  | 217150 | HUNT    | 109  |
| 112413 | SUNNY   | 311  | 166319 | BASIC   | 84   | 189943 | KARLOFF  | 147  | 217170 | DEVIS   | 105  |
| 112415 | MASINI  | 301  | 166353 | GUERTY  | 67   | 190100 | TORÚN    | 22   | 217175 | DEVIS   | 105  |
| 112416 | MASINI  | 301  | 166356 | GUERTY  | 67   | 190110 | RADOM    | 17   | 217180 | DEVIS   | 105  |
| 112419 | MASINI  | 301  | 166358 | GUERTY  | 67   | 190112 | RADOM    | 17   | 217200 | MORAN   | 101  |

| Ref    | Name    | Page | Ref    | Name     | Page | Ref    | Name       | Page |
|--------|---------|------|--------|----------|------|--------|------------|------|
| 217250 | LIENZ   | 65   | 263144 | BASIC    | 85   | 366127 | HOLE       | 219  |
| 224010 | BASIC   | 84   | 266901 | CANDY    | 143  | 366128 | HOLE       | 219  |
| 224012 | BASIC   | 84   | 266910 | HILL     | 142  | 366129 | HOLE       | 219  |
| 224016 | BASIC   | 84   | 266920 | DELL     | 142  | 393326 | TUBES      | 255  |
| 224040 | BASIC   | 83   | 266925 | TINN     | 143  | 400034 | CENEFA     | 125  |
| 224042 | BASIC   | 83   | 278348 | LÁGRIMAS | 115  | 400412 | CENEFA     | 125  |
| 224046 | BASIC   | 83   | 278349 | LÁGRIMAS | 115  | 405411 | NARANJA    | 129  |
| 224310 | BASIC   | 84   | 279130 | FLAT     | 117  | 500007 | PERFIL     | 236  |
| 224312 | BASIC   | 84   | 279140 | FLAT     | 117  | 500011 | PERFIL     | 237  |
| 224316 | BASIC   | 84   | 284310 | WALL     | 107  | 500015 | PERFIL     | 236  |
| 224410 | BASIC   | 82   | 284350 | WALL     | 107  | 500017 | PERFIL     | 236  |
| 224412 | BASIC   | 82   | 361010 | EPSILON  | 71   | 500115 | PERFIL     | 236  |
| 224416 | BASIC   | 82   | 361030 | EPSILON  | 71   | 500334 | DRIVER     | 316  |
| 224510 | BASIC   | 82   | 361050 | EPSILON  | 71   | 501007 | PERFIL     | 236  |
| 224512 | BASIC   | 82   | 365090 | HOLE     | 218  | 501011 | PERFIL     | 237  |
| 224516 | BASIC   | 82   | 365091 | HOLE     | 218  | 501015 | PERFIL     | 236  |
| 229000 | FACTORY | 111  | 365092 | HOLE     | 218  | 502007 | PERFIL     | 236  |
| 229100 | NAVY    | 113  | 365093 | FAST     | 245  | 502011 | PERFIL     | 237  |
| 229200 | NAVY    | 113  | 365094 | FAST     | 245  | 502015 | PERFIL     | 236  |
| 229300 | FACTORY | 111  | 365095 | FAST     | 245  | 700200 | LOPE       | 281  |
| 261235 | VENUS   | 150  | 365096 | FAST     | 245  | 700201 | LOPE       | 281  |
| 261495 | VENUS   | 150  | 366100 | HOLE     | 219  | 700202 | LOPE       | 281  |
| 261595 | VENUS   | 150  | 366101 | HOLE     | 219  | 800200 | STERN      | 145  |
| 262550 | MAIER   | 20   | 366102 | HOLE     | 219  | 800201 | STERN      | 145  |
| 263100 | BASIC   | 84   | 366103 | HOLE     | 219  | 912040 | NAOMI      | 133  |
| 263101 | BASIC   | 84   | 366104 | HOLE     | 219  | 912310 | NAOMI      | 133  |
| 263102 | BASIC   | 84   | 366105 | HOLE     | 219  | 912490 | NAOMI      | 133  |
| 263103 | BASIC   | 84   | 366106 | HOLE     | 218  | 940540 | AQUA       | 243  |
| 263104 | BASIC   | 84   | 366107 | HOLE     | 218  | 982006 | ASSER      | 61   |
| 263110 | BASIC   | 82   | 366108 | HOLE     | 218  | 982036 | ARENADO    | 115  |
| 263111 | BASIC   | 82   | 366109 | HOLE     | 218  | 982136 | HAWKING    | 61   |
| 263112 | BASIC   | 82   | 366110 | HOLE     | 218  | 982137 | TOUCH      | 61   |
| 263113 | BASIC   | 82   | 366111 | HOLE     | 218  | 982138 | TOUCH      | 61   |
| 263114 | BASIC   | 82   | 366112 | HOLE     | 218  | 982139 | TOUCH      | 61   |
| 263120 | BASIC   | 82   | 366113 | HOLE     | 218  | 982351 | CUSTOLIGHT | 47   |
| 263121 | BASIC   | 82   | 366114 | HOLE     | 218  | 982359 | KAHOY      | 74   |
| 263122 | BASIC   | 82   | 366115 | HOLE     | 218  | 982375 | ARON       | 76   |
| 263123 | BASIC   | 82   | 366116 | HOLE     | 218  | 982376 | ARON       | 76   |
| 263124 | BASIC   | 82   | 366117 | HOLE     | 218  | 982740 | NORCIA     | 78   |
| 263130 | BASIC   | 83   | 366118 | HOLE     | 219  |        |            |      |
| 263131 | BASIC   | 83   | 366119 | HOLE     | 219  |        |            |      |
| 263132 | BASIC   | 83   | 366120 | HOLE     | 219  |        |            |      |
| 263133 | BASIC   | 83   | 366121 | HOLE     | 219  |        |            |      |
| 263134 | BASIC   | 83   | 366122 | HOLE     | 219  |        |            |      |
| 263140 | BASIC   | 85   | 366123 | HOLE     | 219  |        |            |      |
| 263141 | BASIC   | 85   | 366124 | HOLE     | 219  |        |            |      |
| 263142 | BASIC   | 85   | 366125 | HOLE     | 219  |        |            |      |
| 263143 | BASIC   | 85   | 366126 | HOLE     | 219  |        |            |      |

CATÁLOGO | CATALOGUE | CATALOGUE | CÁTALOGO



PRODUCTO | PRODUCT | PRODUIT | PRODUCTO

REFERENCIA | REFERENCE | RÉFÉRENCE | REFERÊNCIA

ACCESORIOS ACCESSORIES  
ACCESSOIRES | ACESSÓRIOS

MARCONY | Motor AC | LED 18W 1500lm | 220-240V-50Hz

REF: 75066

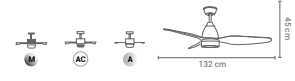

REF 78127 REF 4918

| SPEED | W  | RPM | AIRFLOW (m <sup>3</sup> /min) | dB |
|-------|----|-----|-------------------------------|----|
| 1     | 22 | 90  | 43                            | 25 |
| 2     | 51 | 140 | 110                           | 29 |
| 3     | 80 | 215 | 160                           | 35 |

DALLAS | Motor AC | 2XE27 40Wmax. | 220-240V-50Hz

REF: 75026

BIG SIZE



| SPEED | W  | RPM | AIRFLOW (m <sup>3</sup> /min) | dB |
|-------|----|-----|-------------------------------|----|
| 1     | 17 | 99  | 51                            | 45 |
| 2     | 30 | 133 | 88                            | 48 |
| 3     | 58 | 191 | 130                           | 52 |



REF 78127 REF 4907

SECCIÓN | SECTION | SECTION | SEÇÃO

PLUS PRODUCTO | PLUS PRODUCTO  
PLUS PRODUIT | PLUS PRODUTO

DIMENSIONES | SIZE | DIMENSIONS | DIMENSÕES

DATOS TÉCNICOS | TECHNICAL DATA  
DONNÉES TECHNIQUES | DADOS TÉCNICOS



FAN

CATÁLOGO | CATALOGUE | CATALOGUE | CÁTALOGO

PRODUCTO | PRODUCT | PRODUIT | PRODUCTO

ACCESORIOS ACCESSORIES  
 ACCESSOIRES | ACESSÓRIOS

MATERIAL | MATERIAL | MATERIAL | MATERIAL

PLUS PRODUCTO | PLUS PRODUCTO  
 PLUS PRODUIT | PLUS PRODUTO

COLLECTION | 2019

**STRIPLED 24V | 60LED/m SMD | 4,8W/m**



3000K 3M IP 20 A+ 50

| REF    | CCT   | LM      | COLOR  |
|--------|-------|---------|--------|
| 108977 | 2700k | 340lm/m | blanco |
| 108978 | 4000K | 360lm/m | blanco |

**STRIPLED 24V | 60LED/m SMD | 14,4W/m**



3000K 3M RGB IP 20 A+ 50

| REF    | CCT   | LM      | COLOR  |
|--------|-------|---------|--------|
| 108979 | 2700k | 940lm/m | blanco |
| 108980 | 4000K | 960lm/m | blanco |

**STRIPLED 24V | 60LED/m RGB | 14,4W/m**



3000K 3M RGB IP 20 A+ 50

| REF    | CCT | COLOR  |
|--------|-----|--------|
| 108741 | RGB | blanco |

**STRIPLED 24V | 60LED/m SMD | 4,8W/m**



3000K 3M IP 65 A+ 50

| REF    | CCT   | LM      | COLOR  |
|--------|-------|---------|--------|
| 108936 | 2700k | 290lm/m | blanco |
| 108937 | 4000K | 300lm/m | blanco |

**STRIPLED 24V | 60LED/m SMD | 14,4W/m**



3000K 3M IP 65 A+ 50

| REF    | CCT   | LM      | COLOR  |
|--------|-------|---------|--------|
| 108939 | 2700k | 940lm/m | blanco |
| 108940 | 4000K | 960lm/m | blanco |

**STRIPLED 24V | 60LED/m RGB | 14,4W/m**



3000K 3M IP 65 RGB A+ 50

| REF    | CCT | COLOR  |
|--------|-----|--------|
| 108941 | RGB | blanco |

399 \*Necesario amplificador

**RECORD | APLIQUE | 1x25W E27 | máx.20V~50-60Hz**



IP44 AL + G IP 44

| REF    | W Máx. | E27 | COLOR     |
|--------|--------|-----|-----------|
| 112293 | 1x25W  | E27 | antracita |

**RECORD | BALIZAS | 1x25W E27 | máx.20V~50-60Hz**



IP44 AL + G IP 44

| REF    | W Máx. | E27 | COLOR     |
|--------|--------|-----|-----------|
| 112295 | 1x25W  | E27 | antracita |



SECCIÓN | SECTION | SECTION | SEÇÃO

DIMENSIONES | SIZE | DIMENSIONS | DIMENSÕES

DATOS TÉCNICOS | TECHNICAL DATA  
 DONNÉES TECHNIQUES | DADOS TÉCNICOS



**METAL** | METAL | METAL | METAL



**ALUMINIO** | ALUMINIUM | ALUMINIUM | ALUMÍNIO



**ABS** | ABS | ABS | ABS

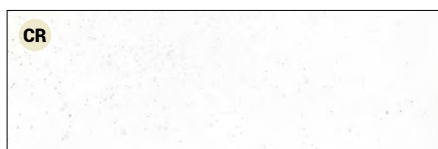

**CERÁMICA** | CERAMIC | CERÁMIQUE | CERÂMICA



**PVC** | PVC | PVC | PVC

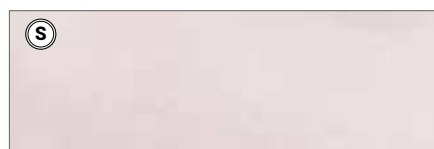

**SILICONA** | SILICONE | SILICONE | SILICONA

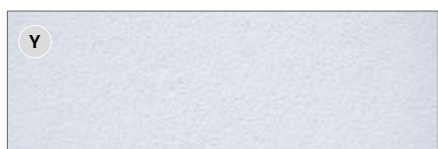

**YESO** | GYPSUM | PLÂTRE | GRESSO

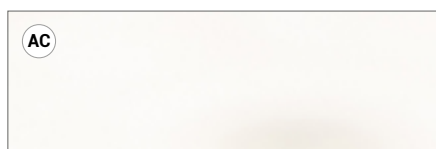

**ACRILICO** | ACRILYC | ACRYLIQUE | ACRÍLICO

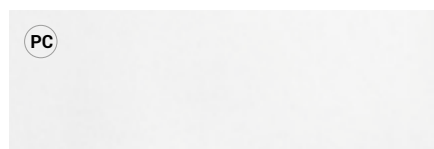

**POLICARBONATO** | PLYWOOD | PLYWOOD | PLYWOOD



**TIFFANY** | TIFFANY | TIFFANY | TIFFANY



**CRISTAL** | GLASS | CRISTAL | VIDRIO



**ALABASTRO** | ALABASTER | ALBÂTRE | ALABASTRO



**MADERA** | WOOD | BOIS | MADEIRA



**PLYWOOD** | PLYWOOD | PLYWOOD | PLYWOOD



**MDF** | MDF | MDF | MDF



**TEXTIL** | TEXTILE | TEXTILE | TÊXTIL



**CUERDA** | PLYWOOD | PLYWOOD | PLYWOOD



**COLORES**  
 COLOR | COLOUR | COR



**BLANCO** | WHITE | BLANC | BRANCO



**NEGRO** | BLACK | NOIR | PRETO



**BRONCE** | BRONZE | BRONZE | BRONZE



**PLATA** | SILVER | ARGENT | PRATA



**DORADO** | GOLD | DORÉ | DOURADO



**COBRE** | COPPER | CUIVREL | COBRE



**CROMO** | CHROME | CHROME | CROME



**MARRÓN** | BROWN | MARRON | BROWN



**NÍQUEL** | NICKEL | NICKEL | NÍQUEL



**ÓXIDO** | OXIDE | OXIDE | OXIDO

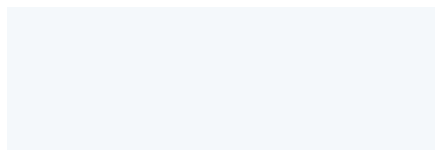

**TRANSPARENTE** | TRANSPARENT | TRANSPARENT | TRANSPARENTE

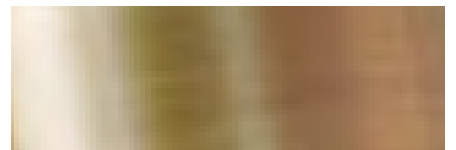

**CUERO VIEJO** | ANTIQUE BRASS | LAITON VIEILLI | COURO VEHLO



**ALUMINIO BROCHADO** | BRUACHING ALUMINUM | BROCHER EN ALUMINIUM | BROCHADEIRA DE ALUMÍNIO

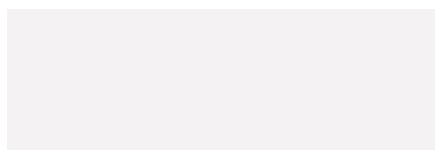

**BLANCO SATINADO** | SATIN WHITE | BLANC SATINÉ | BRANCO CETIM



**MULTICOLOR** | MULTICOLOUR | MULTICULORE | MULTICOLOR



**ANTRACITA** | ANTHRACITE | ANTHRACITE | ANTRACITE



**GRIS OSCURO** | DARK GREY | GRIS FONCÉ | CINZA OSCURO



**GRIS** | GREY | GRIS | CINZA

|  | ES                                 | EN                          | FR                                | PT                               |  | ES                                    | EN                                     | FR   | PT                                     |
|--|------------------------------------|-----------------------------|-----------------------------------|----------------------------------|--|---------------------------------------|--|--|--|
|  | Tensión                            | Voltage                     | Tension                           | Voltagem                         |  | Tipo de casquillo                     | Cap type                               | Type de PAC                                  | Tipo de tampa                          |
|  | Temperatura ambiente               | Ambient temperature         | Température                       | Temperatura ambiente             |  | Driver incluido                       | Included driver                        | Driver inclus                                | Driver incluída                        |
|  | Factor de potencia                 | Power factor                | Facteur de puissance              | Fator de potência                |  | Driver no incluido                    | Driver not included                    | Driver non inclus                            | Driver não incluído                    |
|  | Clase I                            | Class I                     | Classe électrique I               | Classe I                         |  | Agujero de corte                      | Cut hole                               | Découpez                                     | Abrir buraco                           |
|  | Clase II                           | Class II                    | Classe électrique II              | Classe II                        |  | Producto nuevo                        | New product                            | Nouveau produit                              | Novo produto                           |
|  | Clase II                           | Class III                   | Classe électrique III             | Classe III                       |  | Bajo pedido                           | On resquest                            | Sur demande                                  | A pedido                               |
|  | Grado de protección IP             | IP protection degree        | Degré de protection IP            | Nível de proteção IP             |  | Ángulo de apertura                    | Opening angle                          | Angle d'ouverture                            | Ângulo de abertura                     |
|  | Grado de Resistencia IK            | IK resistance degree        | Degré de résistance IK            | Nível de resistência IK          |  | Temperatura de color 2700K            | Colour temperature: 2700K              | Température de couleur: 2700K                | Temperatura de color 2700K             |
|  | Bombilla incluida                  | Bulb included               | Ampoule incluse                   | Lâmpada incluída                 |  | Temperatura de color 3000K            | Colour temperature: 3000K              | Température de couleur: 3000K                | Temperatura de color 3000K             |
|  | Bombilla no incluida               | Bulb not included           | Ampoule non incluse               | Não incluída                     |  | Temperatura de color 3500K            | Colour temperature: 3500K              | Température de couleur: 3500K                | Temperatura de color 3500K             |
|  | Horas de vida                      | Lifetime                    | Heures de vie                     | Horas de vida                    |  | Temperatura de color 4000K            | Colour temperature: 4000K              | Température de couleur: 4000K                | Temperatura de cor 4000K               |
|  | Número de encendidos               | Number of ignitions         | Nombre de démarrages              | Número de ascendidos             |  | Temperatura de color 5000K            | Colour temperature: 5000K              | Température de couleur: 5000K                | Temperatura de color 5000K             |
|  | Regulación en intensidad           | Adjustable intensity        | Intensité ajustable               | Regulação em intensidade         |  | Temperatura de color 5500K            | Colour temperature: 5500K              | Température de couleur: 5500K                | Temperatura de color 5500K             |
|  | No regulable en intensidad         | Non-adjustable intensity    | Intensité non ajustable           | Não ajustável em intensidade     |  | Temperatura de color 6000K            | Colour temperature: 6000K              | Température de couleur: 6000K                | Temperatura de color 6000K             |
|  | Regulación en temperatura de color | Adjustable colour intensity | Température de couleur ajustable  | Regulação da temperatura de cor  |  | Índice de deslumbramiento unificado   | Unified glare rating                   | Unified glare rating                         | Classificação unificada de brilho      |
|  | 3 tonos temperatura de color       | 3 colour intensity          | 3 Intensité de couleur            | 3 tonos da temperatura de cor    |  | Oscilante                             | Oscillating                            | Oscillante                                   | Oscilante                              |
|  | Luz RGB                            | RGB                         | RGB                               | RGB                              |  | Orientable                            | Tilt herad                             | Tête pivotante                               | Ajustável                              |
|  | Eficiencia energética clase A++    | Energy Efficiency Class A++ | Efficacité Énergétique Classe A++ | Eficiência energética Classe A++ |  | Dos funtes de luz                     | Two light sources                      | Deux sources lumineuses                      | Duas fontes de luz                     |
|  | Eficiencia energética clase A+     | Energy Efficiency Class A+  | Efficacité Énergétique Classe A+  | Eficiência energética Classe A+  |  | Dos funtes de luz con distinto ángulo | Two light sources with different angle | Deux sources lumineuses avec angle différent | Duas fontes de luz com ângulo difrente |
|  | Eficiencia energética clase A      | Energy Efficiency Class A   | Efficacité Énergétique Classe A   | Eficiência energética Classe A   |  | Tres funtes de luz                    | Three light sources                    | Trois sources lumineuses                     | Três fontes de luz                     |
|  | Índice de reproducción cromática   | Colour rendering index      | Indice de rendu des couleurs      | Índice reprodução de cor         |  | Cuatro fuentes de luz                 | Four light sources                     | Quatre sources lumineuses                    | Quatro fontes de luz                   |

|  | ES                       | EN                          | FR                        | PT                       |  | ES                                    | EN   | FR                                    | PT                                   |
|--|--------------------------|-----------------------------|---------------------------|--------------------------|--|---------------------------------------|--|---------------------------------------|--------------------------------------|
|  | Dos intensidades         | Two intensities             | Deux intensités           | Duas intensidades        |  | Sin parpadeo                          | No flicker   | Aucun scintillement                   | Sem cintilância                      |
|  | Luz trasera              | Rear light                  | Feu arriere               | Luz traseira             |  | 1,5m cable                            | 1,5m   | 1,5m                                  | 1,5m                                 |
|  | Suspension vertical      | Vertical suspension         | À suspendre en vertical   | Suspensão em vertical    |  | Kit de suspensión                     | Suspension kit                                     | Kit combinés filetés                  | Kit de suspensão                     |
|  | Suspension en horizontal | Horizontal suspension       | À suspendre en horizontal | Suspensão em horizontal  |  | Bateria de Litio                      | Lithium battery                                    | Batterie au lithium                   | Bateria de lítio                     |
|  | Superficie               | Surface                     | Surface                   | Superfície               |  | Autonomía                             | Autonomy   | Autonomie                             | Autonomia                            |
|  | Empotramiento            | Recessed                    | À encastrer               | Encastramento            |  | Motor AC                              | AC engine  | Moteur AC                             | Motor AC                             |
|  | Luminaria de pie         | Floor lamp                  | Lampadaires               | Candeeuri de pé          |  | Motor DC                              | DC engine  | Moteur DC                             | Motor DC                             |
|  | Sobremesa                | Table lamps                 | Lampes                    | Candeeiros de mesa       |  | Número de palas                       | Number of blades                                   | Nombre de pales                       | Número de pás                        |
|  | Producto domótico        | Home automation product     | Produit domotique         | Produto domotico         |  | Modo verano / invierno                | Summer / Winter function                           | Fonction été / hiver                  | Modo Inverno / verão                 |
|  | Adesivo 3M               | Three meter cable           | Trois mètres de câble     | Três metros de cabo      |  | Sensor de temperatura                 | Temperature sensor                                 | Capteur de température                | Sensor de temperatura                |
|  | Difusor de aluminio      | Aluminium diffuser          | Diffuseur en aluminium    | Difusor de alumínio.     |  | Madera natural                        | Natural Wood                                       | Bois Naturel                          | Madeira natural                      |
|  | Sensor de presencia      | Motion sensor               | Détecteur de présence     | Sensor de micro-ondas    |  | Instalacion pegado a techo o con tija | Installation Levelled wiht ceiling or with downrod | Installation ras de plafond avec tige | Instalação colado ao teto o con tubo |
|  | Alto rendimiento         | High-performance            | Haute performance         | Alto desempenho          |  | Apto para habitación XXm²             | Suitable for room XXm²                             | Pour les chambres XXm²                | Adequado para quartos XXm²           |
|  | Mando incluido           | Remote control included     | Télécommande inclue       | Comando incluído         |  | Apto para techo inclinado             | Suitable for at an angle ceiling                   | Apte pour toit incliné                | Adequado para telhado inclinado      |
|  | Mando opcional           | Remote control optional     | Télécommande optionnel    | Comando opcional         |  | Cuerpo                                | Body   | Corps                                 | Corpo                                |
|  | Extensible               | Expandable                  | Extensible                | Extensível               |  | Difusor                               | Diffuser   | Diffuseur                             | Difusor                              |
|  | Alarma y calendario      | Alarm and calendar          | Alarme et calendrier      | Alarme e calendário      |  | Palas                                 | Blades   | Pales                                 | Pas                                  |
|  | Temporizador             | Timer                       | Minuterie                 | Temporizador             |  |                                       |  |                                       |                                      |
|  | Táctil                   | Touch                       | Tactile                   | Tátil                    |  |                                       |  |                                       |                                      |
|  | Pintable                 | Paintable                   | Peinture                  | Pintable                 |  |                                       |  |                                       |                                      |
|  | Resistencia a ser pisado | Resistance to be stepped on | Résistance à être piétiné | Resistência a ser pisada |  |                                       |  |                                       |                                      |

Los diseños, las medidas, los materiales y los colores de este catálogo tienen valor puramente indicativo.

En interés de la clientela, la Empresa se reserva el derecho de modificar los modelos en cualquier momento sin obligación de aviso previo.











[www.sulior.es](http://www.sulior.es)

Calle Verano, 51  
Polígono Industrial Las Monjas  
28870 Torrejón de Ardoz  
Madrid (ESPAÑA)

CIF A28763647